



Albrigi is offering you his 30 years of technical evolution and experience, to improve your winery. Albrigi proposes you 8 new fermentation technologies that develop traditional methods to improve every phase of wine-making process, both for white and red grapes. Please do not hesitate to ask for any technical documentation.

YOUR WINERY DESIGNED BY **US**

**CALL US
DIRECTLY**

**Our engineers are
at your disposition**



SERBATOI INOX - CUVES INOX - INOX BEHÄLTER - STAINLESS STEEL TANKS - TANQUES EN ACERO INOX

DIAMOND

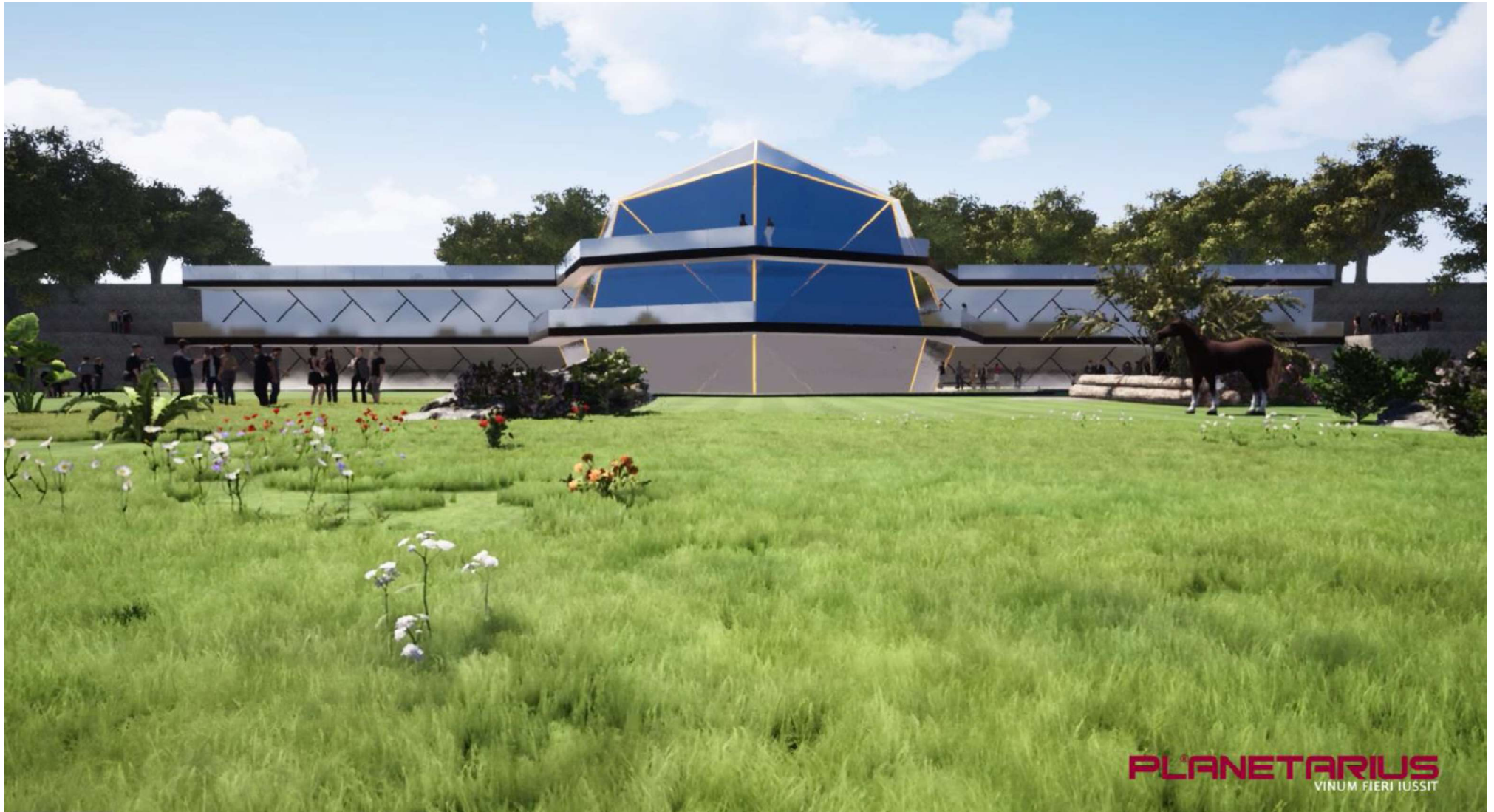

PLANETARIUS
VINUM FIERI IUSSIT

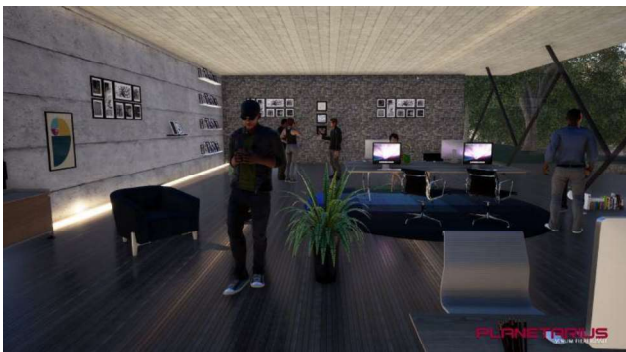

VINEYARD RESORT

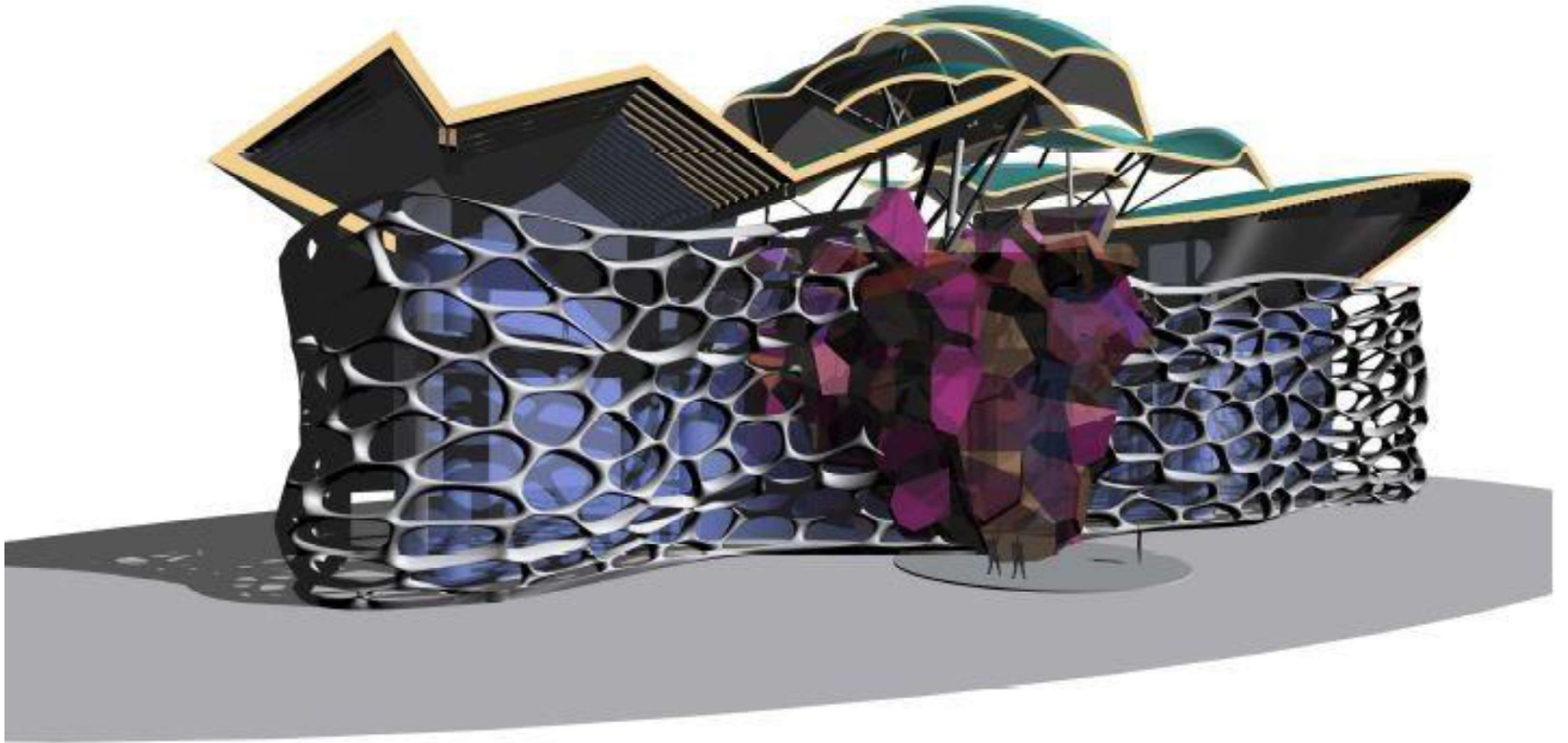

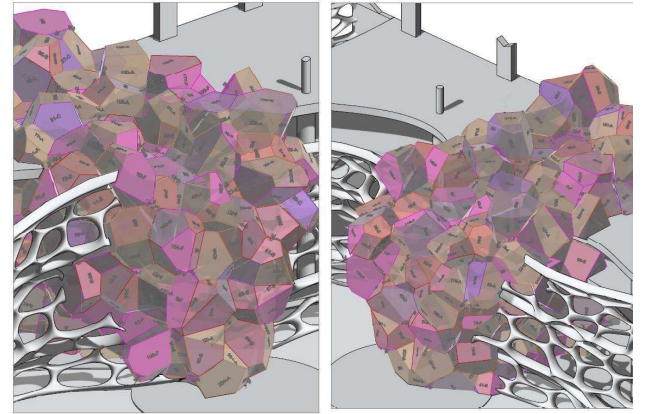
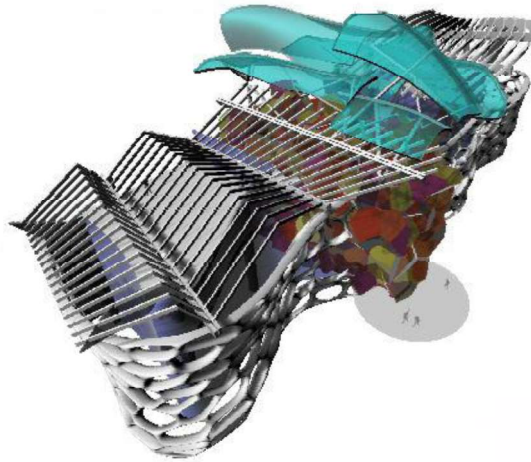
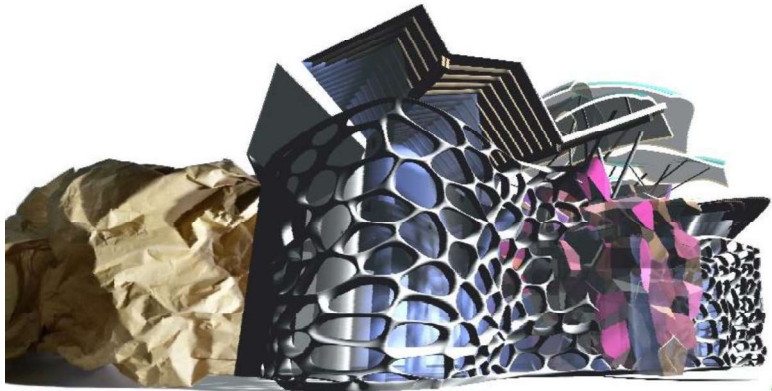
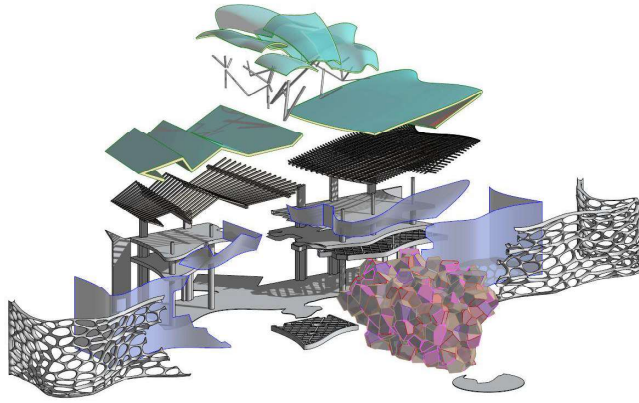
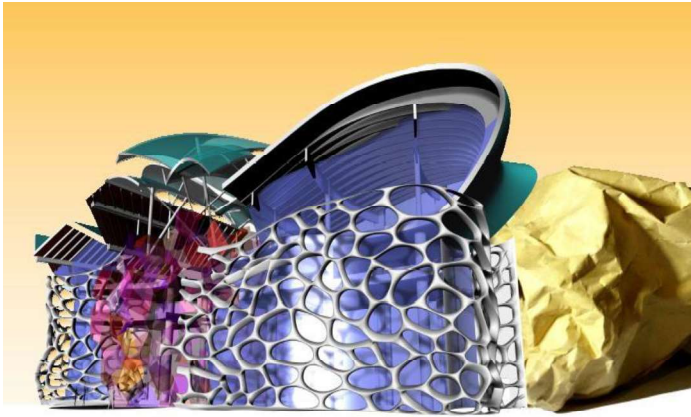

SHELL RESORT

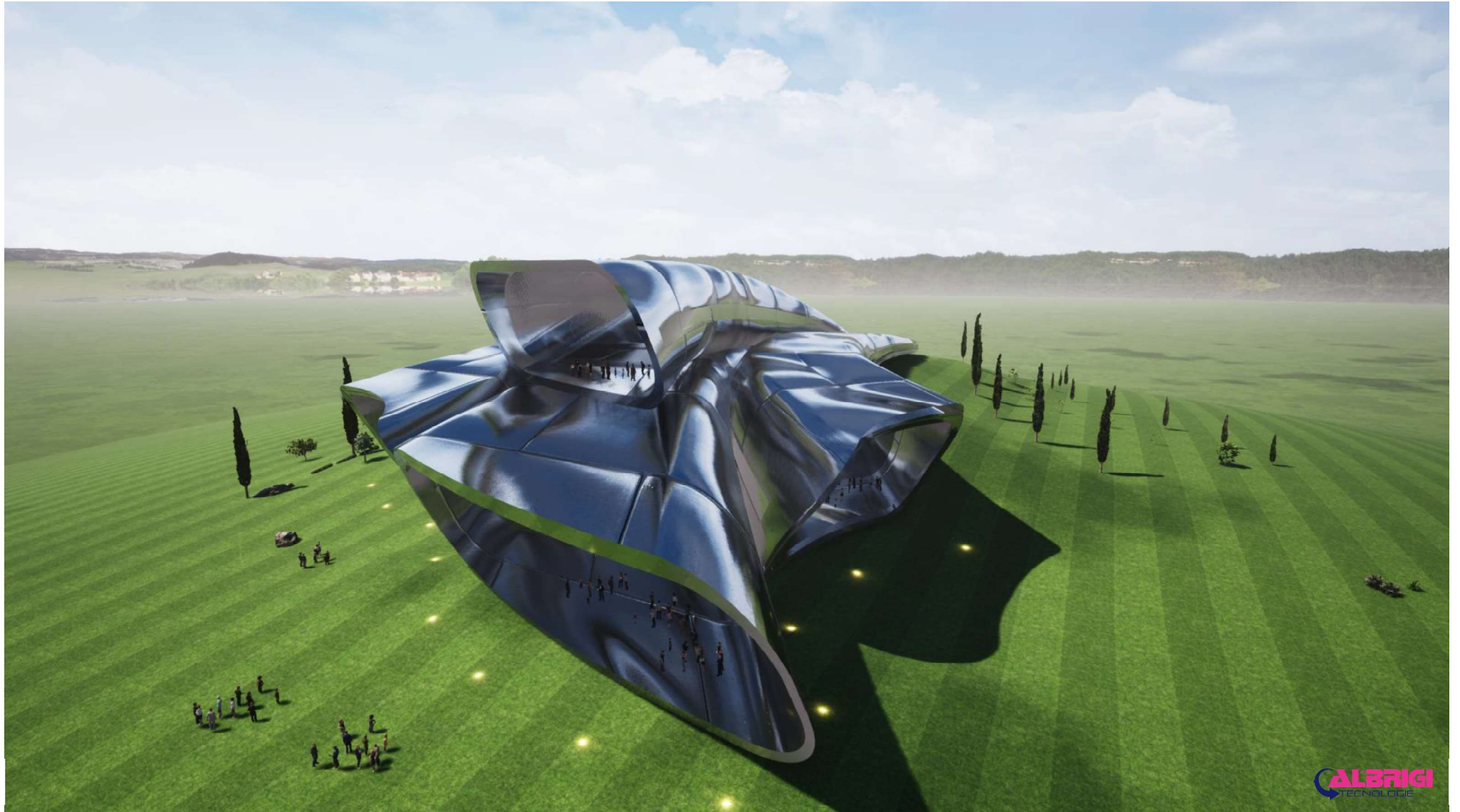

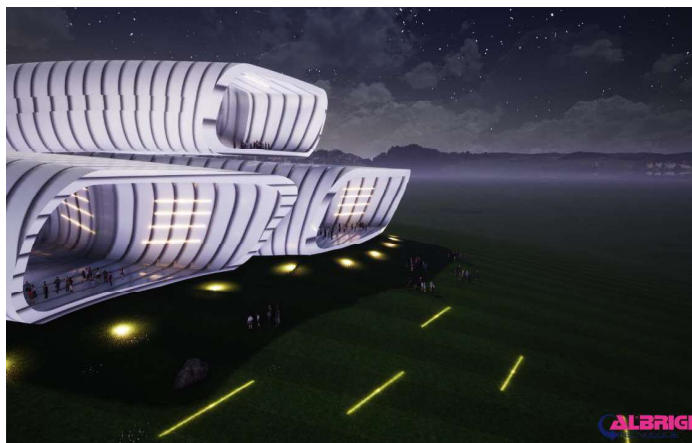
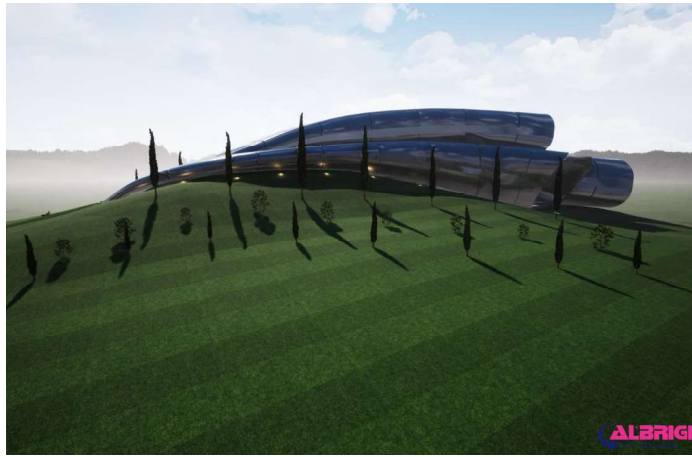
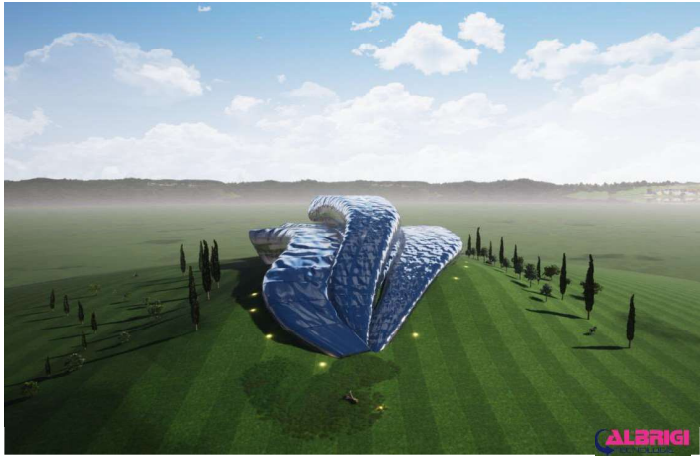

FORT WINE



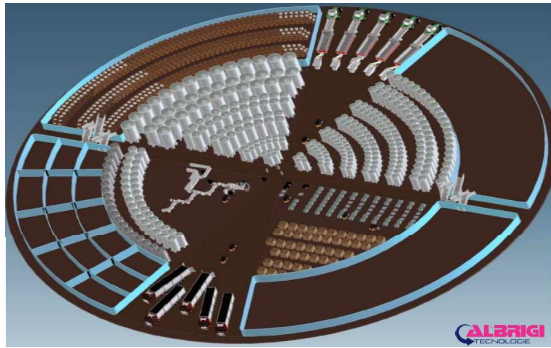
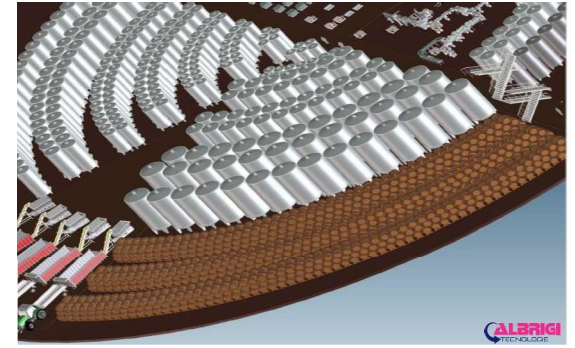
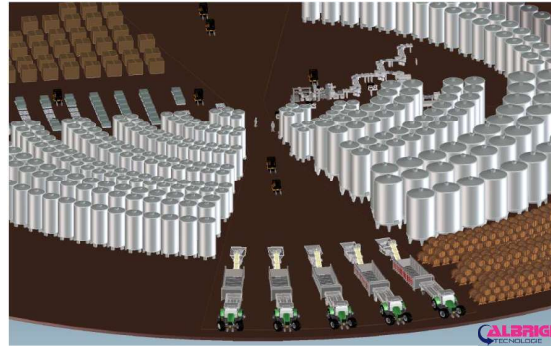
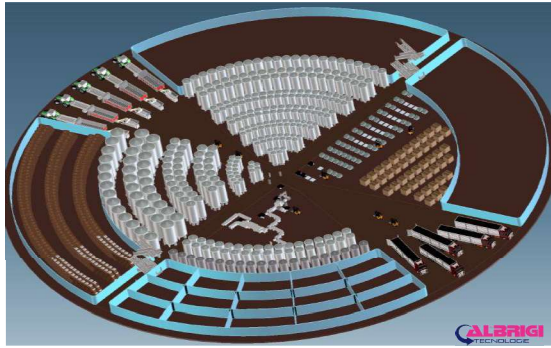

VINEYARD RESORT, DIAMOND, SHELL RESORT and WINE TOWER are a Registered Trademark and a Patented Design owned by ALBRIGI TECNOLOGIE.

Everything shown in this photo (documents, contents, text, images, logos, the artistic work and the graphics) is property of Albrigi Technologie and is protected by copyright, as well as intellectual property rights.

Copying, appropriating, redistributing or reproducing any phrase, content or image on this drawing is therefore absolutely prohibited since it is the fruit of the work and intellect of the author.

The structure of Diamond, Shell Resort and Wine Tower were designed by Pietro Giglio, the structure of Vineyard Resort was designed by Stelvio Erbisti. Copying and reproducing content and images in any form are prohibited.

Any redistribution and publication of the contents and images not expressly authorised by the author is prohibited.

PLANETARIUS-TOP



PLANETARIUS : THE EXCELLENCE FOR RED WINES (AND WHITE WINES)

PLANETARIUS is a new fermentation room for red wines (and white wines), specifically studied for saving time and costs, producing high quality wines and making tests and research for the development of new exclusive kinds of wines, according to the strictest optimization and saving rules and the strictest food and ecological standards.

La winery is composed of three element (Industry 4.0 financeable):

- A) a "cloud" management and control system;
- B) an innovative winemaking system, complete with all services;
- C) a winery suitable for performing high quality winemaking processes for high quality wines, for making research, for saving time, costs and setbacks.

PLANETARIUS is user-friendly with only little staff and highly automated: it rationalizes and controls the whole process, it reduces working times, risks of product contamination and for workers, it helps saving energy and chemical products both for the process and the cleaning.



- The figures speak for themselves:
- 100% process OPTIMIZATION;
 - 100% SAFETY against product contamination / pollution;
 - 80% time SAVING for product transfer, cleaning and sterilisation;
 - 70% manpower SAVING;
 - 30% INCREASE of production;
 - 30% energy SAVING;
 - 100% QUALITY of the product;
 - 100% STYLING & DESIGN;
 - 100% to be VISITED by customers during the fermentation.

PLANETARIUS can be equipped with special fermentation tanks mod. **TOP-FLY** (special for red grapes and for white wines too), mod. **INNOTERMOTANK-FLY** (special for slow dry délestage) or mod. **TINOTERMOTANK-FLY** (special for fast moist délestage), all studied by **ALBRIGI TECHNOLOGIE** for red grapes processing (juice with skins), to obtain high quality wines.

PLANETARIUS fermentation room allows the total control of the winemaking process of red grapes, beginning with the incoming grapes treatment, up to the filtration before bottling. The incoming grapes are selected – washed if required – and taken care of through a highly specialized machines line; thereafter the grapes are crushed and transferred to the fermentation tanks mod. **TOP-FLY** (for white wines too), mod. **INNOTERMOTANK-FLY** (special for délestage) or mod. **TINOTERMOTANK-FLY** (special for délestage) by means of gravity chutes and conveyers and without pumps, therefore matching also biodynamic processing approach. The special and highly technological fermentation tanks mod. **TOP-FLY** by **ALBRIGI TECHNOLOGIE** play the lead in all phases of the production process: fermentation, storage, ageing up to the filtration before bottling. Our special fermentation tanks mod. **TOP-FLY** are perfect for performing personalized processes, researching and testing innovative procedures on different types of grapes, to obtain high quality red wines (and white wines). Our special fermentation tanks mod. **TOP-FLY** allow to best emphasize the potentiality of natural processes and reduce the use of both winemaking and cleaning chemical products.

PLANETARIUS fermentation room PURPOSES AND ADVANTAGES:

- the main purpose is to obtain "VINUM OPTIMUM";
- **PLANETARIUS** is a new revolutionary fermentation room for red grapes: a technological, innovative and safe winery system;
- it allows to rationalize and control the whole productive process and to manage it in an interactive and automatic way;
- it is user-friendly and highly automated: advanced technology never gets obsolete;
- it allows to increase productivity 24 hours a day and reduce working times: therefore it allows to perform more fermentation cycles also during production peaks;
- it is studied to maintain the highest standard of workplace safety and hygiene most of all during production peaks;
- it complies with the strictest food and ecological standards;
- it is studied to take care of the product (crushed grapes, must, red wine, white wine) in all processing phases in order to prevent any alteration / contamination and to guarantee high hygiene standards, even reducing the use of chemical products;
- thanks to its fast gravity conveyers for grapes / musts / wines and the absence of pipes and pumps, it is also ideal for biodynamic processes and prevents the hazard of contamination / pollution / deterioration of the product due to previous cycles leftovers in the pipes;
- it is conceived to produce high quality wines and it is ideal to emphasize the natural peculiarity of red grapes, to test new procedures and to develop new high quality products;
- thanks to its special fermentation tanks, it is ideal to emphasize the innate potentiality of the natural fermentation process;
- it allows to save 30% of energy and winemaking chemical products;
- all the products and by-products / wastes are transferred / removed immediately, since the transfer is managed by specific systems / machines that are all equipped with automatic cleaning systems;
- thanks to its automatic removing systems of by-products, it allows to always maintain high hygiene standards;
- the cleaning systems installed on every part (machines, pipes, fermentation tanks etc.) keep the winery always clean and safe in every production cycle;
- thanks to its simple and automatic systems, it allows to rationalize the process and avoid dead times and can be managed also with reduced staff;
- it allows to save 100% of dead-time (loading / unloading / cleaning) and to work 24/7 on three work shifts, with one only person dedicated to fermentation control;
- workers can work comfortably and safely, mostly on the floor with no need to work at a height: the little stairs and platforms reach small heights, are fixed to rails, protected by railings and designed with the needed safety spaces;
- every element / equipment is easy, comfortable and safe to reach: the staff can easily keep everything under control taking samples, inspecting tanks through manholes, using automatic systems;
- the simple automatic management of recurring processes allows the staff to be dedicated mainly to the critical phases of the process, such as grapes selection and most of all fermentation process etc., since it offers all the operational instruments and tools to interactively control and manage the process;
- the high organization of the process allows to manage the grapes income-selection- fermentation cycles in order to perfectly match and program the ripening and harvesting phases in the vineyard in order to intervene at the right moment;
- thanks to the processing high speed it is possible to absorb and work with maximum care unexpected increases of incoming grapes from the vineyard, perfectly matching the harvest needs also in extreme situations such as after unexpected hail or due to a fast ripening.

PLANETARIUS COMPLIES WITH ALL NEEDS

PLANETARIUS fermentation room is proposed with the following outfittings:

PLANETARIUS-TOP with **TOP-FLY** fermentation tanks (red and white grapes).
TOP-FLY IS A NEW CONCEPT OF FERMENTATION TANK, TOTALLY AUTOMATED, MULTI-FUNCTION, IDEAL FOR ALL KINDS OF GRAPES.
TOP-FLY is the top fermentation tank by **ALBRIGI TECHNOLOGIE**. It is a complete, self-governed, automatic fermentation tank, ideal for red grapes fermentation.

The customized combination of its equipment allows to perform a high number of fermentation and winemaking processes on crushed grapes and musts for white wines and in particular for great red wines, emphasizing as much as possible the natural peculiarity of the product. The automatic control system allows to perform the whole process: from the phase of must to the phase of finished red or white wine, ready for the filtration before bottling, reducing considerably the number of transfers.

PLANETARIUS COMPLIES WITH ALL NEEDS

PLANETARIUS-INNO with **INNOTERMOTANK-FLY** fermentation tanks (délestage). **INNOTERMOTANK-FLY** is a reverse conical fermentation tank (the wide side is at the top)

- A) ideal for soft skin red grapes;
- B) ideal for performing délestage process, both manually and automatically;
- C) beyond délestage process, it is ideal for different fermentation processes of red grapes;
- D) it naturally helps the natural rise of the marc cap during the fermentation;
- E) in the rise, the marc cap expands, spreads and brakes naturally and softly, and gets thinner;
- F) ideal for the must pump over, on a wider and thinner marc cap;
- G) ideal for a natural, intensive and dynamic extraction of color and natural properties of the grapes;
- H) ideal for performing dry délestage process, with almost dry marc: when the marc cap descends to the lower part of the cone, which is the narrowest one, the marc gets compressed and dry (dry délestage);
- I) it helps the settling of the seeds on the bottom;
- J) due to its particular shape, after the fermentation it is perfect for wine storage, helping the natural settling.

PLANETARIUS COMPLIES WITH ALL NEEDS

PLANETARIUS-TINO with **TINOTERMOTANK-FLY** fermentation tanks (délestage). **TINOTERMOTANK-FLY** is a conical fermentation tank (the wide side is at the bottom)

- A) ideal for soft skin red grapes;
- B) ideal for performing délestage process, both manually and automatically;
- C) beyond délestage process, it is ideal for different fermentation processes of red grapes;
- D) during the fermentation and the natural rise of the marc cap, it keeps the marc cap slightly compressed reducing its floating;
- E) ideal for performing fast délestage process, with moist marc: when the marc cap descends in the wide part of the cone, it expands and spreads staying moist (fast délestage);
- F) ideal for a natural, intensive and dynamic extraction of color and natural properties of the grapes;
- G) due to its particular shape, after the fermentation it is perfect for wine storage, helping the natural bûtonnage.

color : ANTHRACITE



color : ORO - GOLD



color : BRONZO - BRONZE



ACCESSORIES

PALITANK / DÉLESTAGE :

It is possible to apply the **PALITANK / DÉLESTAGE** cap breaking system to the fermentation tanks mod. **INNOTERMOTANK** e **TINOTERMOTANK**. Thus the break of marc cap is guaranteed during the délestage process, without creating lees.



ACCESSORIES

SEPARTANK

The use of **SEPARTANK** in the délestage process helps the settling and separation by gravity of skins and seeds from the circulating must; moreover it is possible to control must temperature (cold délestage) and the content of oxygen (oxicontrol).

All the technologies proposed above by **ALBRIGI TECHNOLOGIE** are studied to emphasize the natural winemaking process, reducing as much as possible process times, manpower and the use of chemical products.



N.B. : I PRESENTI DISEGNI RAPPRESENTANO SOLO UNA PROPOSTA SCHEMATICA, CHE VA VERIFICATA IN OGNI SUA PARTE IN FASE DI PROGETTAZIONE PER INTRODURRE LE MODIFICHE EVENTUALMENTE NECESSARIE. TUTTE LE MISURE SONO SOLO INDICATIVE E VANNO VERIFICATE IN LOCO

N.B. : THIS IS ONLY A PRELIMINARY DRAWING, FOR ESTIMATE ONLY, THAT NEEDS TO BE VERIFIED IN EVERY DETAIL DURING THE PROJET, IN ORDER TO INTRODUCE ALL THE NECESSARIES MODIFICATIONS. ALL THE MEASURES ARE APPROXIMATE AND NEED TO BE VERIFIED ON SITE



PLANETARIUS-TOP

DOMANDA DI BREVETTO DEPOSITATA - PATENT PENDING

TA.V. 1b

**LINEA MACCHINE ALLA RICEZIONE UVE
GRAPES RECEPTION EQUIPMENT**

**RICEZIONE UVA
INCOMING GRAPES**

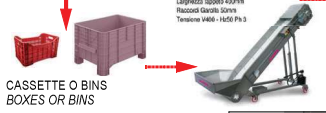
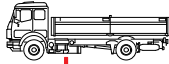

**CASSETTE O BINS
BOXES OR BINS**

**NASTRO TRASPORTATORE
PER UVA
GRAPES CONVEYER BELT**

NASTRI ELEVATORI PER UVA "TE 400"
Nastro elevatore con tappeto in PVC alimentare larghezza 800mm adatto a trasportare uva fresca, disidratata e vitigni fermentati, controllo totalmente in Acciaio Inox AISI 304 con velocità regolabile in altezza su ruote. Completo di braccioli di carico, servomotori e recupero liquido e quadro elettrico.

**TAVOLO VIBRANTE
DOSATORE
DOSER VIBRATING TABLE**

TAVOLO VIBRANTE DOSATORE UVA "TV"
Tavolo vibrante dosatore per uva fresca e disidratata, controllo totalmente in Acciaio Inox AISI 304 con velocità regolabile. Completo di griglia di supporto fissa con assi 2mm con vaschette di recupero e quadro elettrico.

**NASTRO CERNITA UVA
GRAPES SELECTION
CONVEYER BELT**

NASTRI CERNITA UVA "TC"
Per la selezione dell'uva, tappeto in PVC alimentare larghezza 800mm adatto a trasportare uva fresca, disidratata e vitigni fermentati, controllo totalmente in Acciaio Inox AISI 304 con velocità regolabile in altezza su ruote. Completo di braccioli di carico, servomotori e recupero liquido e quadro elettrico.

**NASTRO TRASPORTATORE
PER UVA
GRAPES CONVEYER BELT**

NASTRI ELEVATORI PER UVA "TE 400"
Nastro elevatore con tappeto in PVC alimentare larghezza 800mm adatto a trasportare uva fresca, disidratata e vitigni fermentati, controllo totalmente in Acciaio Inox AISI 304 con velocità regolabile in altezza su ruote. Completo di braccioli di carico, servomotori e recupero liquido e quadro elettrico.

**DIRASPATRICE INOX
STAINLESS STEEL DESTEMMER**

DIRASPATRICE INOX "TOP"
due versioni di velocità
Trattaggio di uva con rotazione di alimentazione con girante, regolazione elettronica velocità, sistema frenato con girante in acciaio inox, con ricambio a velocità di separazione uva, macchina, variazione di velocità meccanica, controllo totalmente in Acciaio Inox AISI 304 con velocità regolabile in altezza su ruote. Completo di braccioli di carico, servomotori e recupero liquido e quadro elettrico.

**NASTRO ELEVATORE PER RASPI
STALKS LIFTING CONVEYER BELT**

NASTRI ELEVATORI PER RASPI "RE"
Nastro elevatore con tappeto in PVC alimentare larghezza 800mm adatto a trasportare uva fresca, disidratata e vitigni fermentati, controllo totalmente in Acciaio Inox AISI 304 con velocità regolabile in altezza su ruote. Completo di braccioli di carico, servomotori e recupero liquido e quadro elettrico.

**NASTRO TRASPORTATORE
PER UVA
GRAPES CONVEYER BELT**

NASTRI ELEVATORI PER UVA "TE 400"
Nastro elevatore con tappeto in PVC alimentare larghezza 800mm adatto a trasportare uva fresca, disidratata e vitigni fermentati, controllo totalmente in Acciaio Inox AISI 304 con velocità regolabile in altezza su ruote. Completo di braccioli di carico, servomotori e recupero liquido e quadro elettrico.

**TAVOLO PER SELEZIONE
AUTOMATICA
AUTOMATIC SELECTION TABLE**

TAVOLO PER SELEZIONE AUTOMATICA "TA"
Tavolo vibrante per la selezione automatica di uva disidratata, controllo totalmente in Acciaio Inox AISI 304 con velocità regolabile in altezza su ruote. Completo di braccioli di carico, servomotori e recupero liquido e quadro elettrico.

**TAVOLO VIBRANTE CERNITA UVA
VIBRATING GRAPES SELECTION
TABLE**

TAVOLO CERNITA UVA VIBRANTE "TV"
Tavolo vibrante per la selezione dell'uva fresca o disidratata, controllo totalmente in Acciaio Inox AISI 304 con velocità regolabile in altezza su ruote. Completo di braccioli di carico, servomotori e recupero liquido e quadro elettrico.

**NASTRO TRASPORTATORE
PER UVA
GRAPES CONVEYER BELT**

NASTRI ELEVATORI PER UVA "TE 400"
Nastro elevatore con tappeto in PVC alimentare larghezza 800mm adatto a trasportare uva fresca, disidratata e vitigni fermentati, controllo totalmente in Acciaio Inox AISI 304 con velocità regolabile in altezza su ruote. Completo di braccioli di carico, servomotori e recupero liquido e quadro elettrico.

**PIGIATRICE A RULLI PER UVA
DIRASPATTA
ROLL CRUSHER FOR
STEMMED GRAPES**

PIGIATRICE A RULLI PER UVA DIRASPATTA
Macchina a rulli con tappeto di alimentazione, tutti i componenti sono regolabili, recupero e quadro elettrico.

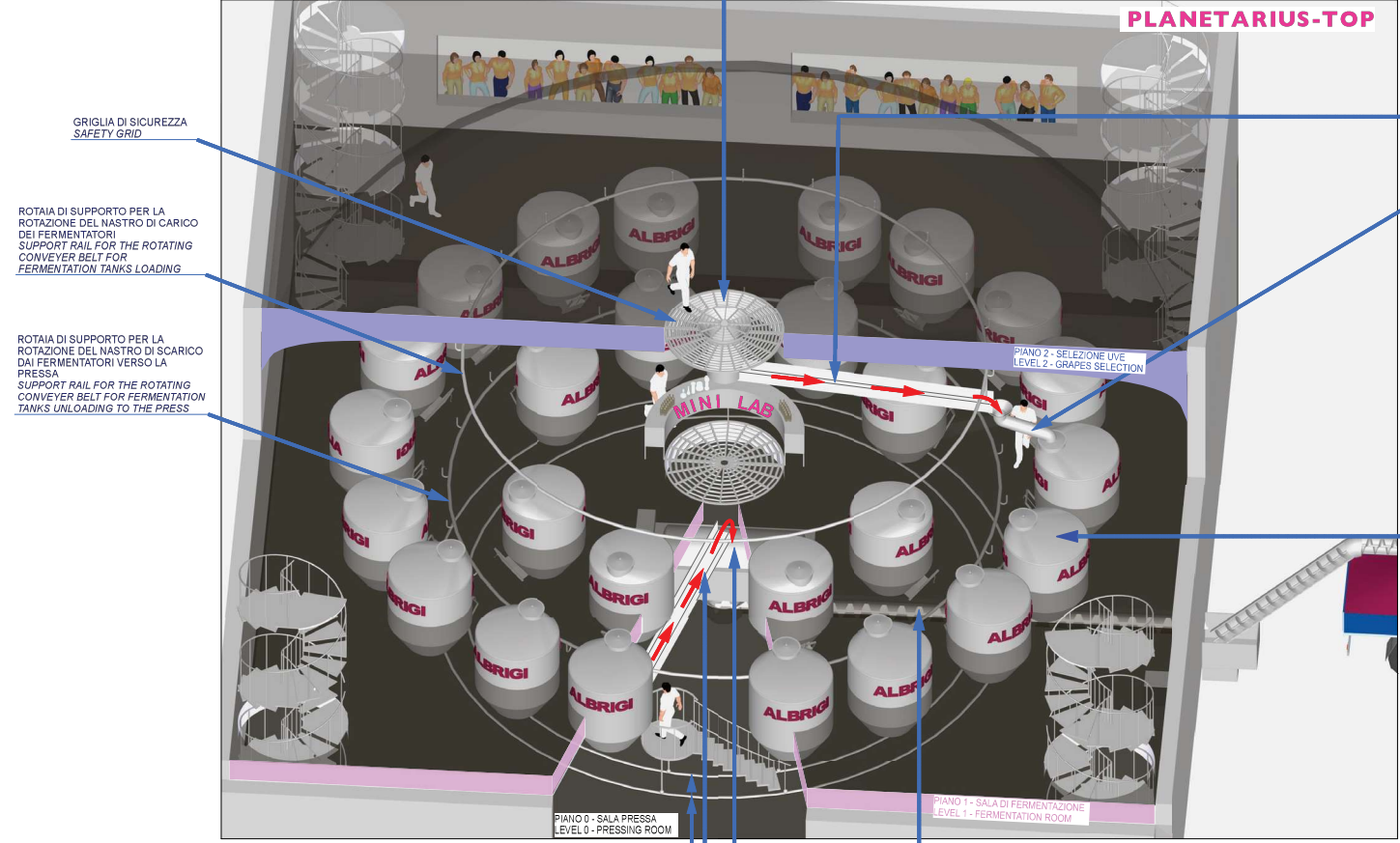

PLANETARIUS-TOP

**GRIGLIA DI SICUREZZA
SAFETY GRID**

**ROTAIA DI SUPPORTO PER LA
ROTAZIONE DEL NASTRO DI CARICO
DEI FERMENTATORI
SUPPORT RAIL FOR THE ROTATING
CONVEYER BELT FOR
FERMENTATION TANKS LOADING**

**ROTAIA DI SUPPORTO PER LA
ROTAZIONE DEL NASTRO DI SCARICO
DAI FERMENTATORI VERSO LA
PRESSA
SUPPORT RAIL FOR THE ROTATING
CONVEYER BELT FOR FERMENTATION
TANKS UNLOADING TO THE PRESS**

**LINEA MACCHINE SVUOTAMENTO FERMENTATORI - VERSO LA PRESSA
FERMENTATION TANKS UNLOADING EQUIPMENT - TO THE PRESS**

**NASTRO TRASPORTATORE
PER VINACCIA
MARC CONVEYER BELT**

NASTRO ELEVATORE PER VINACCIA "TV"
Per allontanamento vinaccia esausta in scorcio da pressa pneumatica, movimento a catena, esecuzione in acciaio inox con telaio su ruote, inclinazione tratto elevatore a 36°, quadro elettrico.

Dimensioni parte orizzontale 1500x1200x465mm
Tensione V400 - H50 Ph 3

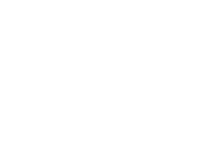

**ROTAIA PER SCALA DI SERVIZIO
STAIR RAIL**

**POMPA PERISTALTICA
PERISTALTIC PUMP**

POMPE PERISTALTICHE "PEV"
Coppo pompa a telaio completamente in acciaio inox, rotore con due fili a pressione regolabile, variazione di velocità elettronica (INVERTER), su ruote con dispositivo di bloccaggio, quadro elettrico con inversione di marcia, due valvole di compensazione.
Senoza Postagomma
Tensione V400 - H50 Ph 3

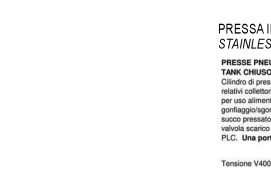

**PRESSA INOX
STAINLESS STEEL PRESS**

PRESSE PNEUMATICHE INOX "PPC-PLUS"
TANK CIRCOLO ERMETICO
Cilindro di pressatura con canallette interne perforate e relativi collettori di scarico, membrana in materiale adossato per uso alimentare, compressore a pila, soffianti per gonfiaggio/sporaggiaggio rapido membrana, vasca di raccolta succo pressato, accessori girante, veicolo di carico stabile, valvola scarico mosto pneumatica, quadro elettrico con PLC. Una porta pneumatica ed ermetica.
Tensione V400 - H50 Ph 3

**PRESSA SU ROTAIE
RAILS FOR PRESS**

**COCLEA PER RIMOZIONE VINACCIA
COCHLEA FOR REMOVING PRESSED SKINS**

**RIMORCHIO PER RIMOZIONE VINACCIA ESAUSTA
PRESSED SKINS REMOVING TRUCK**

**TUBO ROTANTE PER CARICO
FERMENTATORI SU ENTRAMBI I LATI
SWIVELING PIPE FOR LOADING
FERMENTATION TANKS ON BOTH SIDES**



**ARCHIMEDE - SISTEMA DI GESTIONE
E CONTROLLO AUTOMATIZZATO
ARCHIMEDE - MANAGEMENT AND
CONTROL AUTOMATIC SYSTEM**



**LINEA NASTRI RIEMPIMENTO FERMENTATORI
FERMENTATION TANKS LOADING CONVEYER BELTS**

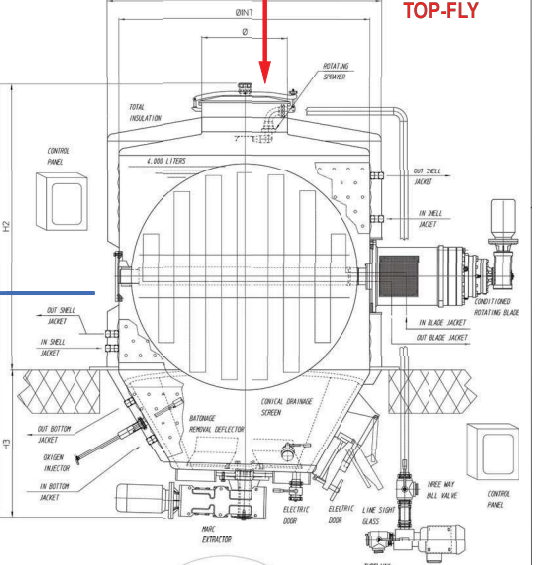

N.B. I PRESENTI DISEGNI RAPPRESENTANO SOLO UNA PROPOSTA SCHEMATICA, CHE VA VERIFICATA IN OGNI SUA PARTE IN FASE DI PROGETTAZIONE PER INTRODURRE TUTTE LE MODIFICHE EVENTUALMENTE NECESSARIE. TUTTE LE MISURE SONO SOLO INDICATIVE E VANNO VERIFICATE IN LOCO.
N.B. THIS IS ONLY A PRELIMINARY DRAWING, FOR ESTIMATE ONLY, THAT NEEDS TO BE VERIFIED IN EVERY DETAIL DURING THE PROJECT, IN ORDER TO INTRODUCE ALL THE NECESSARY MODIFICATIONS. ALL THE MEASURES ARE APPROXIMATE AND NEED TO BE VERIFIED ON SITE.

ENO FRIENDS | **ALBRIGI TECNOLOGIE** | **PLANETARIUS-TOP** | **TAV. 2**

DOMANDA DI BREVETTO DEPOSITATA - PATENT PENDING

PROJECT RESEARCH AND DEVELOPMENT | **DESIGN** FORM AND SUBSTANCE | **FIN** WE FINANCE YOU | **TRAINING** CONTINUOUS TRAINING

PIANTA PIANO 1 - LIVELLO SERBATOI
LEVEL 1 - TANKS

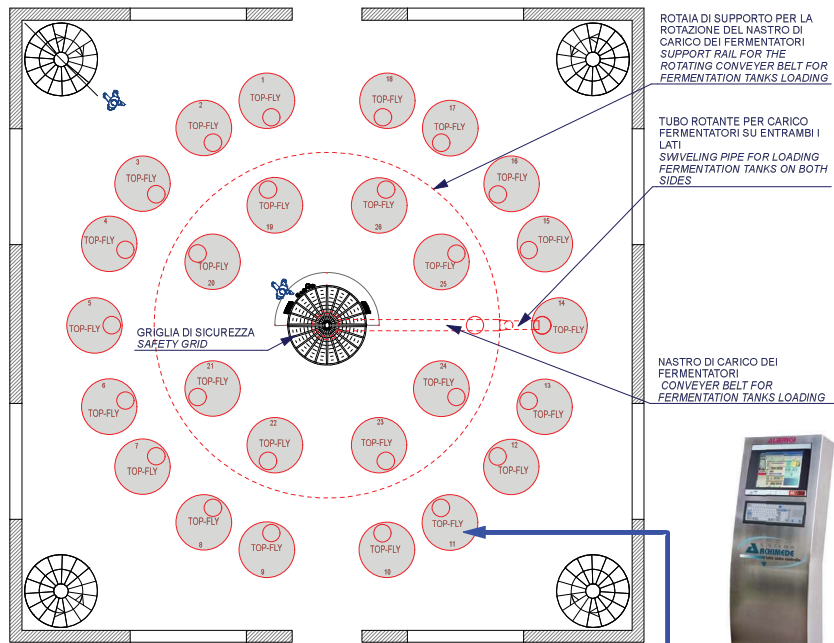

SEZIONE
SECTION

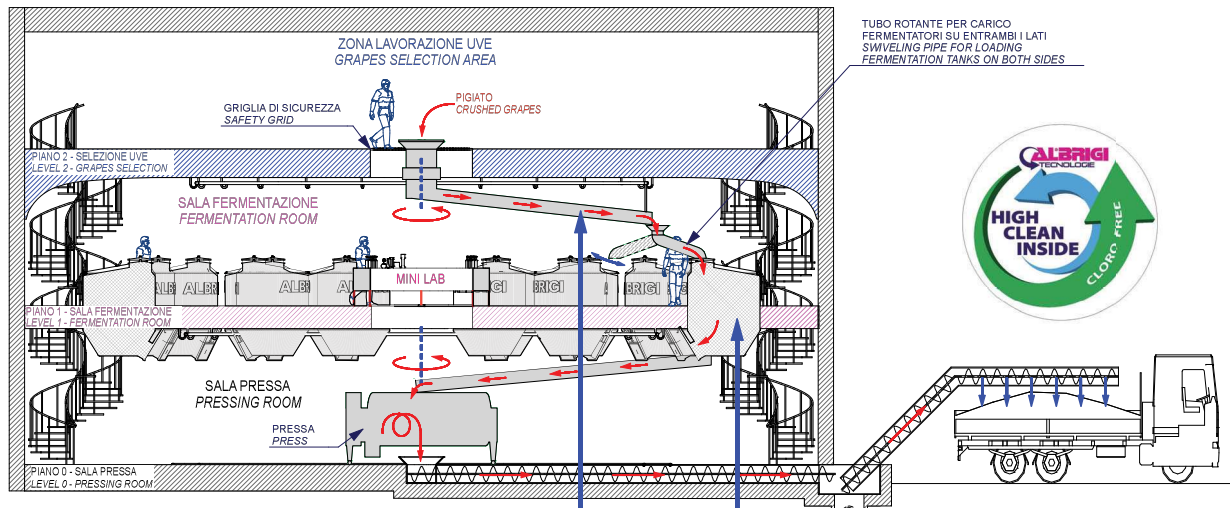

ARCHIMEDE :
SISTEMA DI GESTIONE E
CONTROLLO AUTOMATIZZATO
MANAGEMENT AND CONTROL
AUTOMATIC SYSTEM



NASTRO TRASPORTATORE
PER UVA
GRAPES CONVEYER BELT

NASTRI ELEVATORI PER UVA "THE STAR"
Nastro elevatore con tappeto in PVC antiscivolo larghezza
400mm adatto a trasportare uve intere, sbrinate e vinacci
fermentate, costruito totalmente in Acciaio Inox AISI 304
con bilanciere regolabile in altezza su ruote. Completo di
sterminaglie di carico, scabbio di recupero liquido e quadro
elettrico.

Portata da 2 a 15 Tonn
"Portata maggior su richiesta"
Larghezza tappeto 400mm
Potenza 6 Kw/10 Kw
Tensione V400 - H50 Ph 3

LINEA NASTRI RIEMPIMENTO FERMENTATORI
FERMENTATION TANKS LOADING CONVEYER BELTS

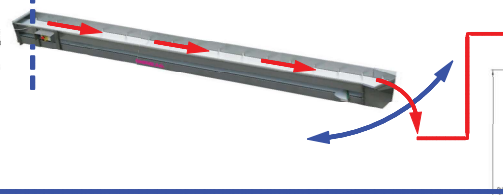

TOP-FLY

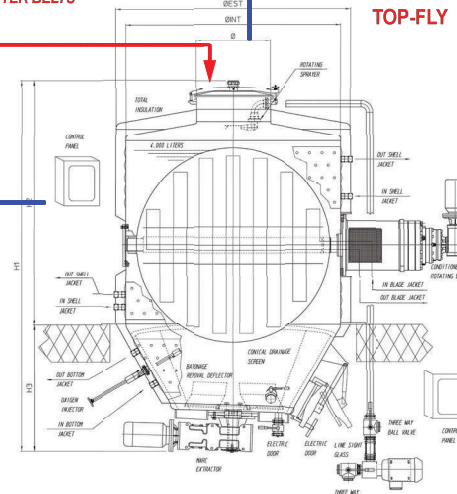

PLANETARIUS-TOP



LA CANTINA PUO' ESSERE VISITATA QUANDO E' IN
FUNZIONE, IN VENDEMMIA

THE WINERY CAN BE VISITED BY GUESTS WHILE IT IS
WORKING, DURING THE HARVEST



N.B.: I PRESENTI DISEGNI RAPPRESENTANO SOLO UNA PROPOSTA SCHEMATICA, CHE VA VERIFICATA IN
OGNI SUA PARTE IN FASE DI PROGETTAZIONE PER INTRODURRE TUTTE LE MODIFICHE
EVENTUALMENTE NECESSARIE. TUTTE LE MISURE SONO SOLO INDICATIVE E VANNO VERIFICATE
IN LOCO

N.B.: THIS IS ONLY A PRELIMINARY DRAWING, FOR ESTIMATE ONLY, THAT NEEDS TO BE VERIFIED IN
EVERY DETAIL DURING THE PROJET, IN ORDER TO INTRODUCE ALL THE NECESSARIES
MODIFICATIONS. ALL THE MEASURES ARE APPROXIMATE AND NEED TO BE VERIFIED ON SITE



PLANETARIUS-TOP
FERMENTATION ROOM

PIOMANDA DI BREVETTO DEPOSITATA - PATENT PENDING

TAV. 3

PIANTA PIANO 0 - PRESSA
LEVEL 0 - PRESS

ROTAIA DI SUPPORTO PER LA ROTAZIONE DEL NASTRO DI SCARICO DEI FERMENTATORI VERSO LA PRESSA
SUPPORT RAIL FOR THE ROTATING CONVEYER BELT FOR FERMENTATION TANKS UNLOADING TO THE PRESS

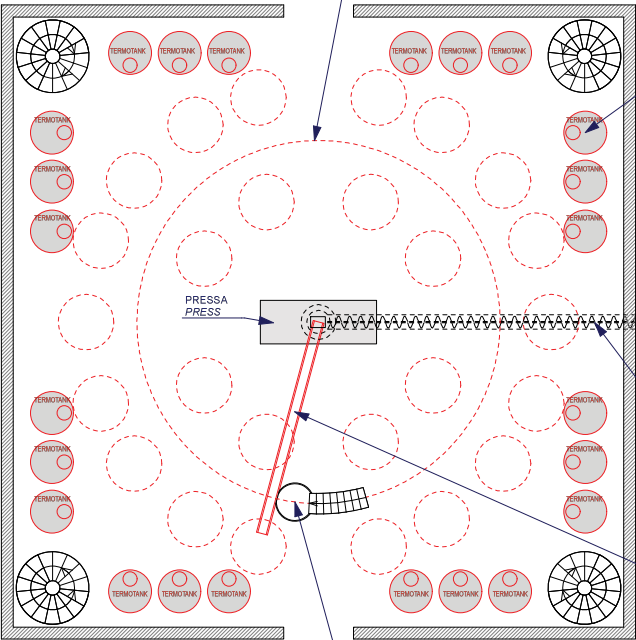

TERMO-TANK: SERBATOI DI FERMENTAZIONE E STOCCAGGIO
TERMO-TANKS: FERMENTATION AND STORAGE TANKS

RIMORCHIO PER RIMOZIONE VINACCE ESAUSTE
TRUCK FOR REMOVING PRESSED SKINS

COCLEA PER RIMOZIONE VINACCE ESAUSTE
COCHLEA FOR REMOVING PRESSED SKINS

NASTRO TRASPORTATORE ROTANTE PER SCARICO VINACCIA
MARC UNLOADING SWIVELING CONVEYER BELT

PEDANA DI SERVIZIO SU ROTAIA
SERVICE PLATFORM ON RAIL

SEZIONE
SECTION

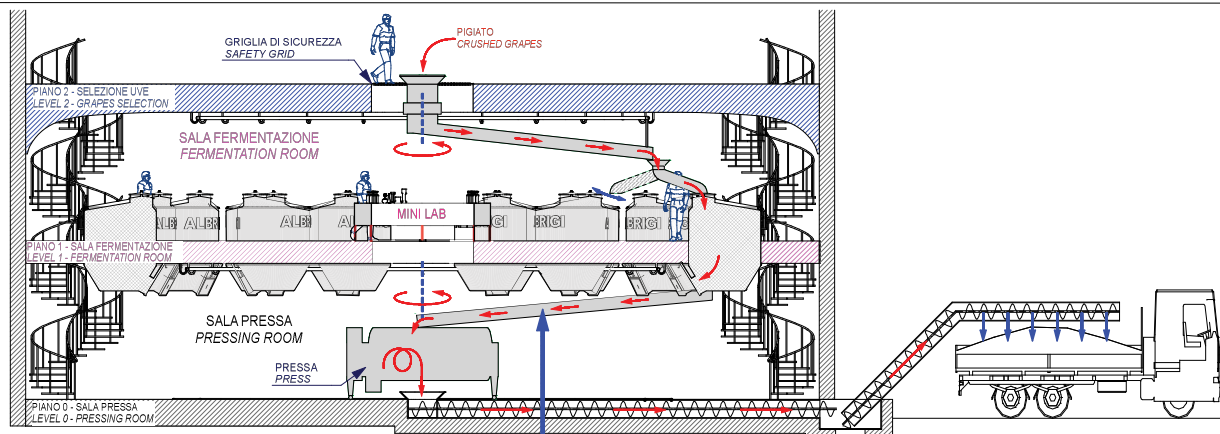

LINEA NASTRI SVUOTAMENTO FERMENTATORI - VERSO LA PRESSA
FERMENTATION TANKS UNLOADING CONVEYER BELTS - TO THE PRESS

NASTRO TRASPORTATORE PER VINACCIA
MARC CONVEYER BELT

NASTRO ELEVATORE PER VINACCIA "M"
Per allungamento vinaccia essicata in scarico da pressa pneumatica, movimento a sistema elevatore in acciaio inox con telaio su ruote, inclinazione tratto elevatore a 30°, quadro elettrico

Dimensioni parte anziosata: 1500x1200x450mm
Tensione V400 - H450 Ph 3

PRESSA INOX
STAINLESS STEEL PRESS

PRESSE PNEUMATICHE INOX "PPC-PLUS"
TANK CRUCIO ERETICO
Cilindro di pressatura con canalotta interna perforata e relativi collettori di scarico, membrana in materiale adossato per uso alimentare, compressore a palette, soffiatore con gonfiaggio/spruffaggio rigido, membrana, vasca di raccolta succo pressato, raccordi gonfiabile, valvola di carico assistita, valvola scarico mosto pneumatico, quadro elettrico con PLC. Una porta pneumatica ad ermetico.

Tensione V400 - H450 Ph 3



PRESSA SU ROTAIE
RAILS FOR PRESS

POMPA PERISTALTICA PERISTALTIC PUMP

POMPE PERISTALTICHE "PE"
Corpo pompa e helix completamente in acciaio inox, rotore con due rulli a pressione regolabile, variatore di velocità elettronico (INVERTER), su ruote con dispositivo di bloccaggio, quadro elettrico con inversione di marcia, due valvole di compressione
Senza Portogomma
Tensione V400 - H450 Ph 3



AI TERMO-TANK: SERBATOI DI FERMENTAZIONE DEI MOSTI E DI STOCCAGGIO DEI VINI
TO TERMO-TANKS: MUST FERMENTATION TANKS AND WINE STORAGE TANKS



COCLEA PER RIMOZIONE VINACCIA
COCHLEA FOR REMOVING PRESSED SKINS

RIMORCHIO PER RIMOZIONE VINACCE ESAUSTE
PRESSED SKINS REMOVING TRUCK

ARCHIMEDE:
SISTEMA DI GESTIONE E CONTROLLO AUTOMATIZZATO
MANAGEMENT AND CONTROL AUTOMATIC SYSTEM



TOP-FLY

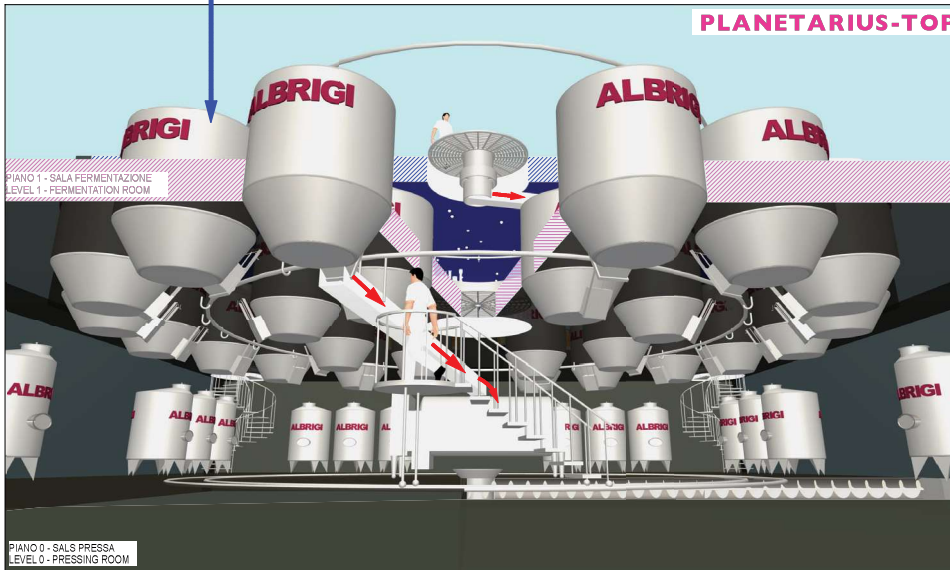
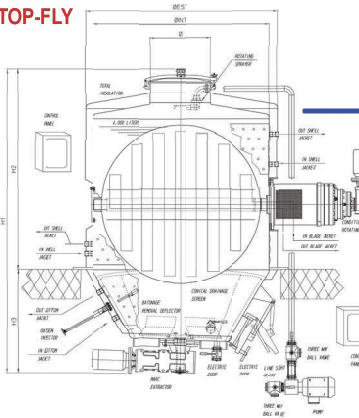

N.B.: I PRESENTI DISEGNI RAPPRESENTANO SOLO UNA PROPOSTA SCHEMATICA, CHE VA VERIFICATA IN OGNI SUA PARTE IN FASE DI PROGETTAZIONE PER INTRODURRE TUTTE LE MODIFICHE EVENTUALMENTE NECESSARIE. TUTTE LE MISURE SONO SOLO INDICATIVE E VANNO VERIFICATE IN LOCO

N.B.: THIS IS ONLY A PRELIMINARY DRAWING, FOR ESTIMATE ONLY, THAT NEEDS TO BE VERIFIED IN EVERY DETAIL DURING THE PROJECT, IN ORDER TO INTRODUCE ALL THE NECESSARY MODIFICATIONS. ALL THE MEASURES ARE APPROXIMATE AND NEED TO BE VERIFIED ON SITE



VOLVOTERMOTANK e TOP-FLY

VOLVOTERMOTANK



TOP-FLY UP



TOP TANK : IL FERMENTATORE MULTIFUNZIONE AUTOMATICO

NUOVO FERMENTATORE MULTI FUNZIONE NOSTRO MODELLO AL TOP DELLA GAMMA

TOP TANK È UNA NUOVA FILOSOFIA, È UN FERMENTATORE AUTOMATICO CHE PUÒ SVOLGERE TUTTI I TIPI DI OPERAZIONI DI FERMENTAZIONE E LAVORAZIONE DEI MOSTI E DEI VINI IN CANTINA = **TOP TANK** È IL TOP DEI FERMENTATORI

TOP TANK È UN SERBATOIO FERMENTATORE MULTIFUNZIONALE CHE PUÒ SVOLGERE TUTTE LE SEGUENTI OPERAZIONI CON ESTREMA PRECISIONE PER FARE VINI DI ALTA QUALITÀ

- FERMENTAZIONE PIGIATI / MOSTI
- CONTROLLO TOTALE DELLA MASSA MOSTO-BUCCIA IN FERMENTAZIONE
- SCARICO DELLA VINACCIA ANCHE DIRETTAMENTE IN PRESSA PER GRAVITÀ
- CRIMACERAZIONE UVE BIANCHE E ROSSE
- RIFERMENTAZIONE UVE INTERE O DIRASPATE FRESCHE O APPASSITE
- DÉLESTAGE UMIDO O SECCO
- BÂTONNAGE
- SEPARAZIONE E SCARICO DEI VINACCIOLI
- CHIARIFICA A FREDDO DEI MOSTI (SENZA VINACCIA) BIANCHI O ROSSI
- RISCALDAMENTO DEI MOSTI CON LIEVITI
- MALOLATTICA
- RIMONTAGGIO DEL MOSTO IN AUTOMATICO DURANTE LA ROTAZIONE DELLA PALA E DURANTE LA FERMENTAZIONE OLTRE CHE NEL DÉLESTAGE
- FLOTTAZIONE
- OSSIGENAZIONE DEI MOSTI
- STABILIZZAZIONE TARTARICA O FERMENTAZIONE MALOLATTICA
- GESTIONE CON IPAD O IPHONE O TELECOMANDO
- TRAVASO VINI E MOSTI
- LAVAGGIO AUTOMATICO
- ISOLAMENTO TOTALE DEL FERMENTATORE

CON TOP TANK SI PRODUCONO VINI GIÀ FINITI, PRONTI PER ESSERE FILTRATI E IMBOTTIGLIATI

TOP TANK È INNOVAZIONE

SERBATOIO FERMENTATORE MULTIFUNZIONE NOSTRO MODELLO **TOP TANK** = È UNA NUOVA FILOSOFIA.

TOP TANK CONTROLLA PERFETTAMENTE LA MASSA PIGIATO/MOSTO/BUCCIA E SCARICA LE VINACCE MECCANICAMENTE. PUÒ ESSERE FORNITO CON PIEDI O MONTATO A CAVALLO DI DUE PIANI INSERITO IN UN APPOSITO FORO RICAVATO NEL SOLAIO: IN QUESTO MODO SI CARICA IL PIGIATO DA SOPRA OPERANDO DAL PIANO SUPERIORE E SI SCARICA LA VINACCIA DA SOTTO MECCANICAMENTE OPERANDO DAL PIANO INFERIORE.

TOP TANK È UN SERBATOIO FERMENTATORE COMPLETO E INNOVATIVO, CHE PUÒ SVOLGERE TUTTE LE OPERAZIONI DI FERMENTAZIONE E LAVORAZIONE DEI MOSTI E DEI VINI IN CANTINA:

TOP TANK E' UN FERMENTATORE MULTIFUNZIONE = TOP TANK È IL TOP DEI FERMENTATORI

MASSA IN FERMENTAZIONE = CON LA PALA ROTANTE TERMOCONDIZIONATA BASTANO POCCHI GIRI AL GIORNO PER CONTROLLARE PERFETTAMENTE LA TEMPERATURA ANCHE AL CENTRO DELLA MASSA MOSTO/BUCCIA IN FERMENTAZIONE: IN TAL MODO LA MASSA MOSTO/BUCCIA RESTA TUTTA OMOGENEA E A TEMPERATURA CONTROLLATA, EVITANDO LA STRATIFICAZIONE DELLE BUCCE NEL MOSTO E FAVORENDO AL MASSIMO IL CONTATTO MOSTO-BUCCIA

SOSPESO AL SOLAIO PUÒ SCARICARE LA VINACCIA DIRETTAMENTE IN PRESSA PER GRAVITÀ = INOLTRE AUTOMATIZZANDO IL SISTEMA NON SERVE AGIRE MANUALMENTE MA SI PUÒ COMANDARE CON RADIOCOMANDO

MACERAZIONI, FERMENTAZIONI SPECIALI, SALASSI = UVE BIANCHE/ROSSE DIRASPATE INTERE, PIGIATE FRESCHE O MOLTO APPASSITE, CON ROTAZIONE TOTALE DELLA MASSA PER FARE AMARONI, RIPASSI, ICE WINE, SALASSI O DOPPIA FERMENTAZIONE

CRIMACERAZIONE = CON PIGIATI DIRASPATI DI UVE BIANCHE E ROSSE A TEMPERATURE CONTROLLATE

RIFERMENTAZIONE = DI UVA AGGIUNTA GIÀ DIRASPATA A CHICCO INTERO, SU PIGIATI IN FERMENTAZIONE (FERMENTAZIONE MALOLATTICA IN ALCOLICA)

DÉLESTAGE = DÉLESTAGE TOTALE PER GRAVITÀ, IN MANUALE O IN AUTOMATICO, CON LA POSSIBILITÀ DI PORTARE LA VINACCIA SIA A SECCO CHE IN UMIDO, CON SCARICO DEL MOSTO DIRETTO NEL NOSTRO DECONTATORE SEPARTANK PER SEPARARE VINACCIOLI E VINACCE

BÂTONNAGE = È POSSIBILE ESEGUIRE IL BÂTONNAGE DEI VINI SU TUTTA LA MASSA LIQUIDA, SOLLEVANDO I LIEVITI FINO ALLA PARTE ALTA DEL FERMENTATORE

SCARICO DEI VINACCIOLI = DISPOSITIVO DI ESTRAZIONE DEI VINACCIOLI DEPOSITATI SUL FONDO DEL FERMENTATORE

CHIARIFICA A FREDDO DEI MOSTI (SENZA VINACCIA) BIANCHI O ROSSI = A TEMPERATURE CONTROLLATE DA +4°C A +12°C DI TUTTA LA MASSA, MANTENENDOLA A TEMPERATURA OMOGENEA

RISCALDAMENTO DEI LIEVITI O DEI VINI = POSSIBILITÀ DI RISCALDARE IL CONO DEL FONDO PER FAVORIRE LA PARTENZA DELLA FERMENTAZIONE NELLA ZONA DOVE SONO POSIZIONATI I LIEVITI, O DI RISCALDARE I VINI PER FARE LA FERMENTAZIONE MALOLATTICA

TRAVASO MOSTI E VINI = SI PUÒ ESEGUIRE QUALSIASI OPERAZIONE DI TRAVASO IN AUTOMATICO

OSSIGENAZIONE DEI MOSTI E PIGIATI = È POSSIBILE FARE L'OSSIGENAZIONE DEI MOSTI E PIGIATI BIANCHI / ROSSI

RIMONTAGGIO DEL MOSTO IN AUTOMATICO IN CONTEMPORANEA CON LA ROTAZIONE DELLA PALA DURANTE LA FERMENTAZIONE OLTRE CHE NEL DÉLESTAGE = È POSSIBILE ESEGUIRE IL RIMONTAGGIO DEI MOSTI IN OGNI PROCESSO

FLOTTAZIONE = È POSSIBILE ESEGUIRE LA FLOTTAZIONE

STABILIZZAZIONE TARTARICA O FERMENTAZIONE MALOLATTICA = PORTANDO I VINI A -5°C PER FARE DECONTARE IL TARTARICO E A +30°C PER FARE LA FERMENTAZIONE MALOLATTICA

LAVAGGIO = IMPIANTO FISSO DI LAVAGGIO AUTOMATICO

GESTIONE E CONTROLLO DA REMOTO = PUÒ ESSERE COMANDATO CON UN TELECOMANDO A DISTANZA, DA IPAD O IPHONE

ISOLAMENTO TOTALE DEL FERMENTATORE = CON LA POSSIBILITÀ DI SCEGLIERE IL COLORE DELL'ISOLAMENTO = INOX - ORO - ANTRACITE - BLU - BRONZO - VINACCIA ECC. ECC.

TOP TANK : THE AUTOMATIC MULTIFUNCTION FERMENTATION TANK

NEW MULTI FUNCTION FERMENTATION TANK, OUR TOP OF THE RANGE

TOP TANK IS A NEW PHILOSOPHY, IT IS AN AUTOMATIC FERMENTATION TANK THAT CAN PERFORM ALL KINDS OF OPERATIONS OF FERMENTATION AND MUST/WINE PROCESSING IN THE WINERY = **TOP TANK** IS THE TOP OF FERMENTATION TANKS

TOP TANK IS A MULTIFUNCTION FERMENTATION TANK THAT CAN PERFORM ALL THE FOLLOWING OPERATIONS WITH EXTREME PRECISION TO PRODUCE HIGH QUALITY WINES

- FERMENTATION OF MUSTS AND CRUSHED GRAPES
- TOTAL CONTROL OF THE MUST-SKIN FERMENTING MASS
- MARC UNLOADING EVEN DIRECTLY INTO THE PRESS BY GRAVITY
- CRYOMACERATION OF WHITE AND RED GRAPES
- RE-FERMENTATION OF INTACT GRAPES OR DESTEMMED GRAPES, BOTH FRESH OR DRIED
- DÉLESTAGE : DRY OR MOIST MODE
- BÂTONNAGE
- GRAPE PIPS SETTLING AND UNLOADING
- COLD CLARIFICATION OF RED OR WHITE MUSTS (WITHOUT MARC)
- HEATING OF MUSTS WITH YEASTS
- MALOLACTIC FERMENTATION
- AUTOMATIC PUMP OVER OF THE MUST TOGETHER WITH THE ROTATION OF BLADE AND WITH THE FERMENTATION, MORE THAN DURING THE DÉLESTAGE
- FLOTATION
- MUSTS OXYGENATION
- TARTARIC STABILIZATION OR MALOLACTIC FERMENTATION
- REMOTE CONTROL, OR WITH IPAD/IPHONE
- WINES AND MUSTS TRANSFER
- AUTOMATIC CLEANING
- TOTAL INSULATION OF THE TANK

WITH TOP TANK YOU CAN PRODUCE FINISHED WINES, READY TO BE FILTERED AND BOTTLED

TOP TANK IS INNOVATION

MULTIFUNCTION FERMENTATION TANK OUR MODEL **TOP TANK** = IT IS A NEW PHILOSOPHY.

TOP TANK CAN PERFECTLY CONTROL THE MASS OF CRUSHED GRAPES/MUST/SKINS AND CAN UNLOAD THE MARC MECHANICALLY. IT CAN BE EQUIPPED WITH LEGS OR MOUNTED BETWEEN TWO FLOORS, INTO A SUITABLE HOLE MADE IN THE SLAB: THUS CRUSHED GRAPES CAN BE LOADED FROM ABOVE, WORKING ON THE UPPER FLOOR, AND THE MARC CAN BE UNLOADED FROM BELOW, WORKING ON THE LOWER FLOOR.

TOP TANK IS A FERMENTATION TANK THAT CAN PERFORM ALL THE OPERATIONS OF FERMENTATION AND MUST / WINE PROCESSING IN THE WINERY:

TOP TANK IS A MULTIFUNCTION FERMENTATION TANK = TOP TANK IS THE TOP OF FERMENTATION TANKS

FERMENTING MASS = THANKS TO THE CONDITIONED ROTATING BLADE, A FEW ROTATING CYCLES PER DAY ARE ENOUGH TO PERFECTLY CONTROL THE TEMPERATURE EVEN IN THE MIDDLE OF THE MASS OF MUST/SKINS DURING THE FERMENTATION: THUS THE MASS OF MUST/SKINS REMAINS HOMOGENIZED, THE TEMPERATURE CAN BE CONTROLLED, PREVENTING THE STRATIFICATION OF THE SKINS IN THE MUST AND FAVOURING AT MOST THE CONTACT BETWEEN MUST AND SKINS

HANGING IN SUITABLE HOLES MADE IN THE SLAB, IT CAN UNLOAD THE MARC DIRECTLY INTO THE PRESS BY GRAVITY = MOREOVER BY AUTOMATIZING THE SYSTEM IT IS NOT NECESSARY TO OPERATE MANUALLY BUT IT IS POSSIBLE TO MANAGE IT WITH A REMOTE CONTROL

MACERATIONS, SPECIAL FERMENTATIONS, SAIGNÉE = WHITE / RED GRAPES WITHOUT STALK, CRUSHED BOTH FRESH OR VERY DRY, WITH TOTAL REVOLUTION OF THE MASS BY MEANS OF THE ROTATING BLADE FOR MAKING AMARONE WINE, RIPASSO WINE, ICE WINE, SAIGNÉE OR DOUBLE FERMENTATION

CRYOMACERATION = WITH DESTEMMED CRUSHED WHITE AND RED GRAPES, AT CONTROLLED TEMPERATURES

RE-FERMENTATION = OF ADDED DESTEMMED GRAPES WITH HOLE BERRIES INTO FERMENTATION MUST (ALCOHOLIC MALOLACTIC FERMENTATION)

DÉLESTAGE = TOTAL DÉLESTAGE, BY GRAVITY. IT CAN BE DONE MANUALLY OR AUTOMATICALLY, WITH BOTH DRY MARC OR MOIST MARC, UNLOADING THE MARC DIRECTLY INTO OUR SETTLING TANK SEPARTANK TO SEPARATE GRAPE PIPS AND MARC

BÂTONNAGE = IT IS POSSIBLE TO DO BÂTONNAGE OF WINES ON ALL THE LIQUID MASS, LIFTING THE YEASTS UP TO THE TOP OF THE FERMENTATION TANK

DISCHARGE OF GRAPE PIPS = SPECIAL DEVICE FOR THE EXTRACTION OF GRAPE PIPS SETTLED ON THE BOTTOM OF THE FERMENTATION TANK

COLD CLARIFICATION OF WHITE AND RED MUSTS (WITHOUT MARC) = AT CONTROLLED TEMPERATURES +4°C TO +12°C OF THE WHOLE MASS, AT HOMOGENEOUS TEMPERATURE

HEATING OF YEASTS OR WINES = IT IS POSSIBLE TO HEAT UP THE BOTTOM CONE TO HELP THE FERMENTATION START IN THE PLACE WHERE YEASTS ARE POSITIONED, OR TO HEAT UP WINES FOR THE MALOLACTIC FERMENTATION

TRANSFER OF MUSTS AND WINES = IT IS POSSIBLE TO AUTOMATICALLY PERFORM EVERY KIND OF TRANSFER OF MUSTS AND WINES

OXYGENATION OF MUSTS AND CRUSHED GRAPES = IT IS POSSIBLE TO OXYGENATE WHITE AND RED MUSTS AND CRUSHED GRAPES

AUTOMATIC PUMP OVER OF THE MUST TOGETHER WITH THE ROTATION OF THE BLADE, BOTH DURING THE FERMENTATION AND DURING THE DÉLESTAGE = IT IS POSSIBLE TO PUMP OVER THE MUSTS DURING EVERY PHASE

FLOTATION = IT IS POSSIBLE TO DO THE FLOTATION

TARTARIC STABILIZATION OR MALOLACTIC FERMENTATION = COOLING WINES DOWN TO -5°C TO HELP THE SETTLING OF THE TARTARIC ACID AND HEATING WINES UP TO +30°C FOR THE MALOLACTIC FERMENTATION

CLEANING = FIXED AUTOMATIC CLEANING SYSTEM

REMOTE MANAGEMENT AND CONTROL = IT CAN BE MANAGED WITH A REMOTE CONTROL OR BY IPAD OR IPHONE

TOTAL INSULATION OF THE FERMENTATION TANK = WITH THE POSSIBILITY TO CHOOSE THE COLOUR OF THE INSULATION = STAINLESS STEEL - GOLD - ANTHRACITE - BLUE - BRONZE - MARC COLOUR ETC. ETC.

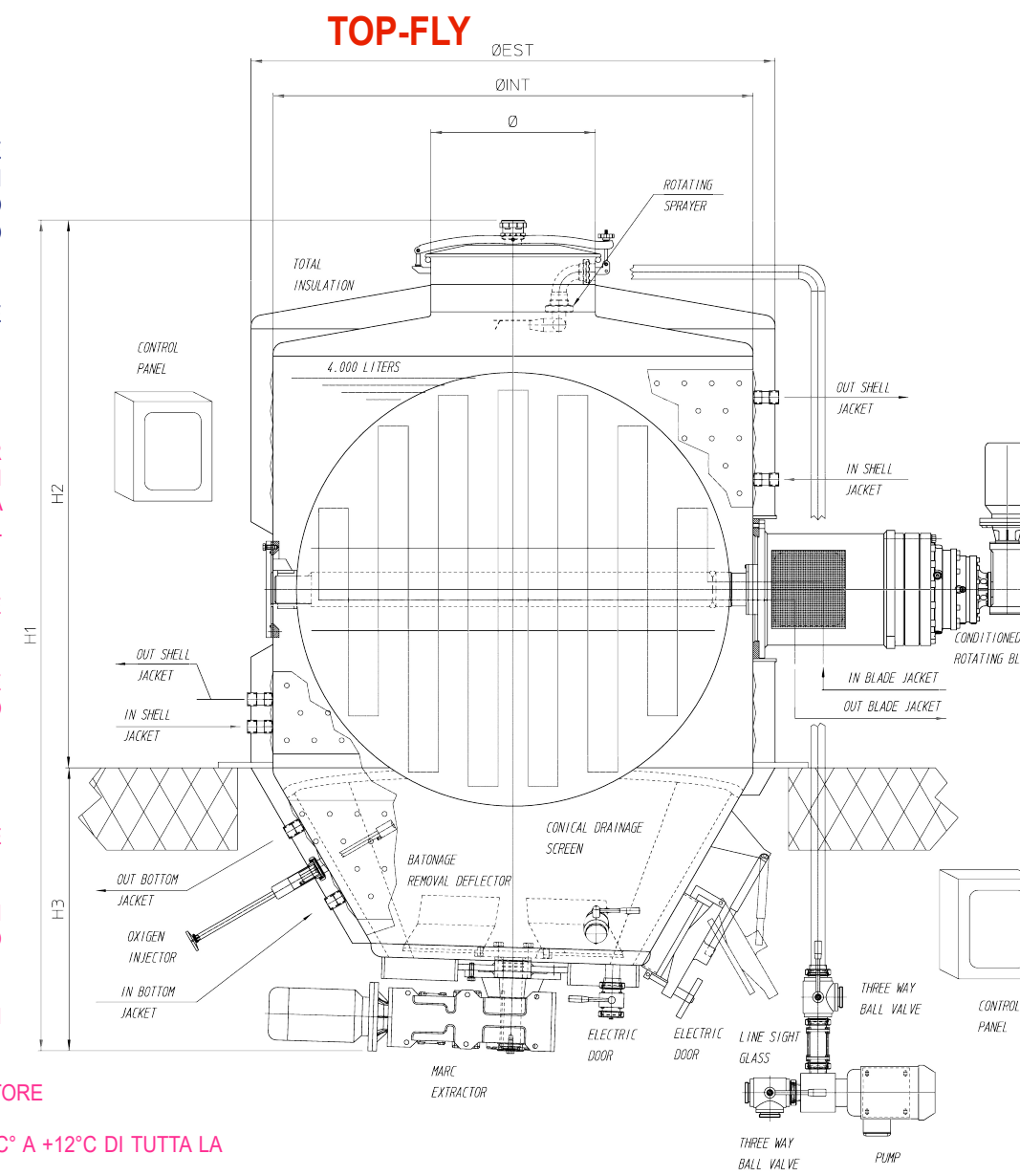

N.B.: I PRESENTI DISEGNI RAPPRESENTANO SOLO UNA PROPOSTA SCHEMATICA, CHE VA VERIFICATA IN OGNI SUA PARTE IN FASE DI PROGETTAZIONE PER INTRODURRE TUTTE LE MODIFICHE EVENTUALMENTE NECESSARIE. TUTTE LE MISURE SONO SOLO INDICATIVE E VANNO VERIFICATE IN LOCO

N.B.: THIS IS ONLY A PRELIMINARY DRAWING, FOR ESTIMATE ONLY, THAT NEEDS TO BE VERIFIED IN EVERY DETAIL DURING THE PROJECT, IN ORDER TO INTRODUCE ALL THE NECESSARIES MODIFICATIONS. ALL THE MEASURES ARE APPROXIMATE AND NEED TO BE VERIFIED ON SITE



PLANETARIUS-TOP

DOMANDA DI BREVETTO DEPOSITATA - PATENT PENDING

TAV. 5

TINOTERMOTANK : IL FERMENTATORE IDEALE PER FARE IL DÉLESTAGE MANUALE O AUTOMATICO, VELOCE E UMIDO

THE IDEAL FERMENTATION TANK FOR MANUAL OR AUTOMATIC, FAST MOIST DÉLESTAGE

TINOTERMOTANK



TINOTERMOTANK-FLY UP



TINOTERMOTANK-FLY UP OFFRE LA POSIZIONE PIU' COMODA PER FARE I CONTROLLI DALL'ALTO DURANTE LA FASE DI FERMENTAZIONE

TINOTERMOTANK-FLY UP OFFERS THE MOST COMFORTABLE POSITION TO MAKE CHECKS FROM ABOVE DURING THE FERMENTATION



TINOTERMOTANK-FLY DOWN

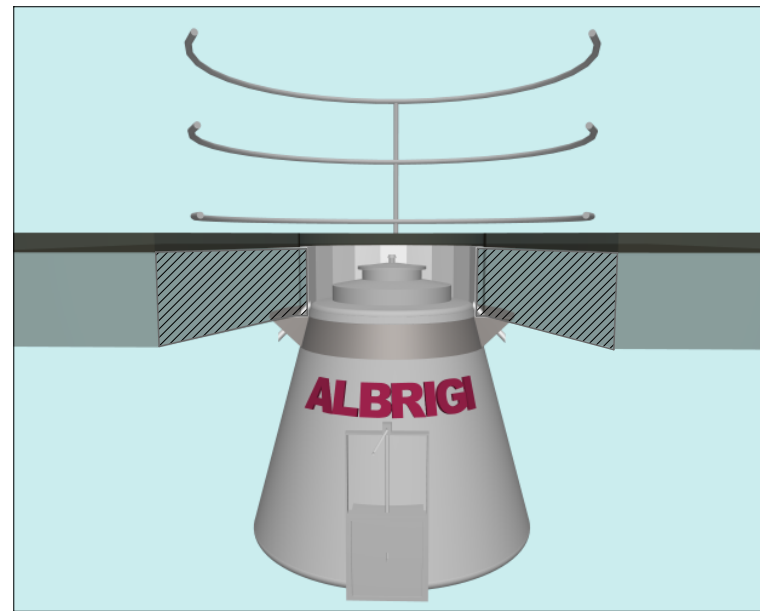
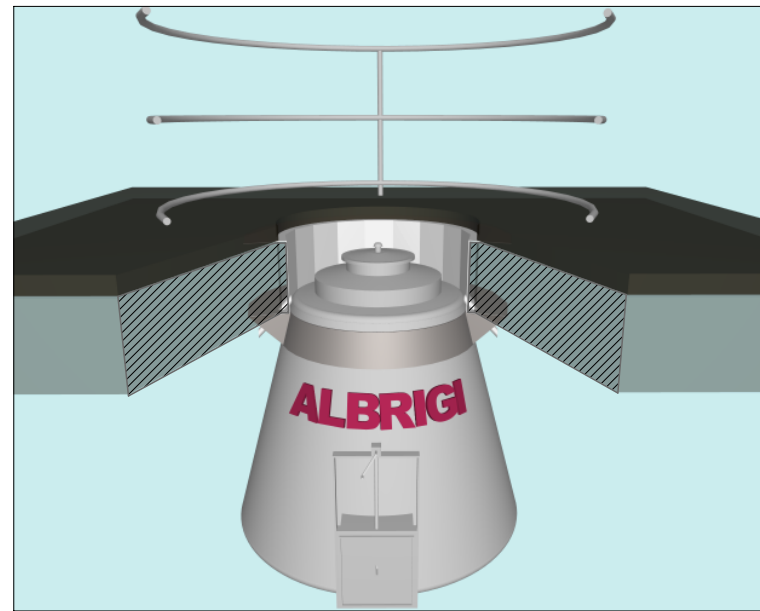

TINOTERMOTANK-FLY DOWN chiuso a collo alto long neck manhole

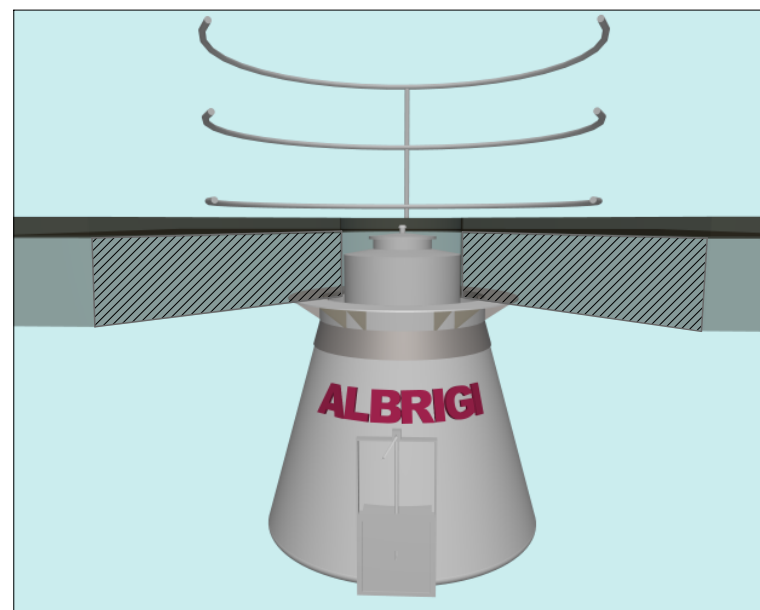
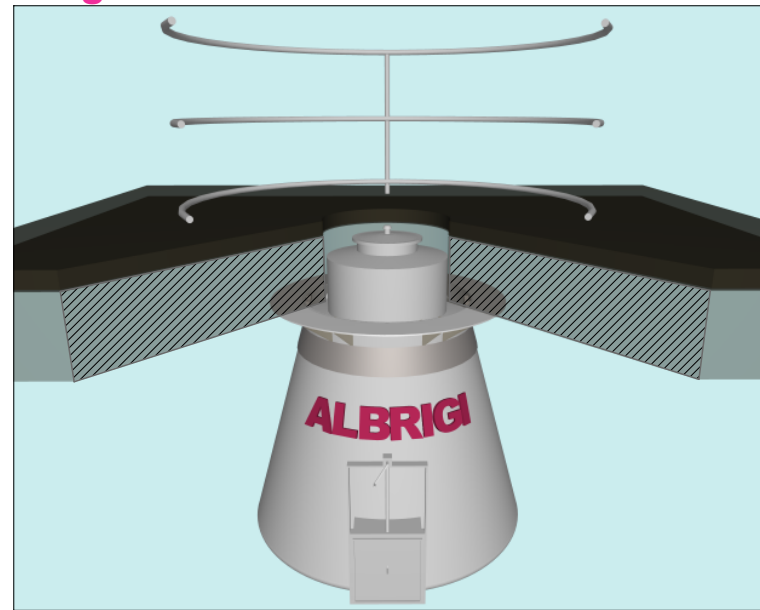

TINOTERMOTANK con PALITANK (DÉLESTAGE)

PRINCIPALI CARATTERISTICHE DEL FERMENTATORE

IDEALE PER FARE IL DÉLESTAGE VELOCE E UMIDO

- A) durante la fermentazione delle uve rosse il cappello di vinacce è contrastato dalla sagoma conica nella sua risalita naturale e si compatta mantenendo il contatto con il mosto sottostante;
- B) durante il délestage il cappello di vinaccia scende e grazie a PALITANK si rompe;
- C) arrivando sul fondo, nella parte più larga del serbatoio, il cappello di vinaccia si allarga e si distende: si può pertanto fare il délestage umido (con un po' di mosto);
- D) la sagoma del serbatoio, conica con la parte più larga in basso, favorisce la distensione del cappello di vinaccia e la sua irrorazione nella successiva fase di rimontaggio del mosto.

FASI DEL DÉLESTAGE

TINOTERMOTANK 1° FASE:

INIZIO DELLA FERMENTAZIONE: All'inizio della fermentazione con uve rosse il cappello di vinaccia è sciolto nel mosto

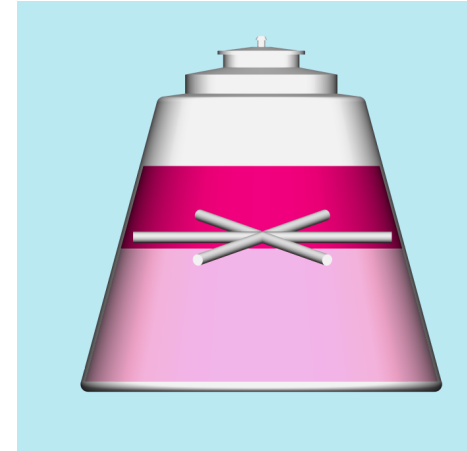

TINOTERMOTANK 2° FASE:

DURANTE LA FERMENTAZIONE: INNALZAMENTO CONTRASTATO E COMPATTAZIONE DEL CAPPELLO DI VINACCIA IN MODO NATURALE: il cappello di vinacce viene mantenuto bagnato, a contatto con il mosto sottostante in fermentazione.

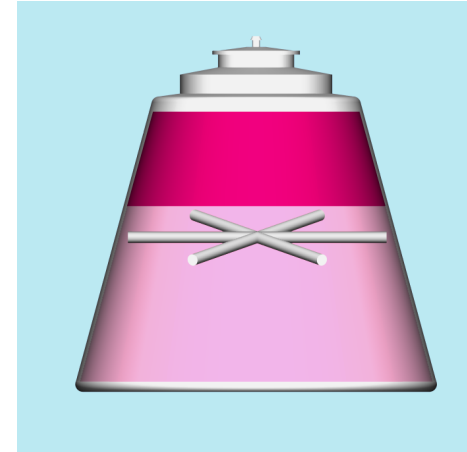

TINOTERMOTANK 3° FASE:

DÉLESTAGE VELOCE UMIDO: ROTTURA DEL CAPPELLO DI VINACCIA, ALLARGAMENTO E DISTENSIONE DELLE VINACCE SUL FONDO IN UMIDO, IN MODO NATURALE

le vinacce sul fondo sono disgregate e distese, leggermente umide di mosto. In questo modo si raffreddano leggermente in modo naturale prima di ricevere il mosto tiepido o raffreddato e risalire.

Successivamente viene rimontato il mosto fresco o raffreddato che provoca uno shock termico sulla vinaccia calda e la fa risalire; ripassando attraverso i pali rompicapello, il cappello di vinaccia si rompe e si disgrega ulteriormente.

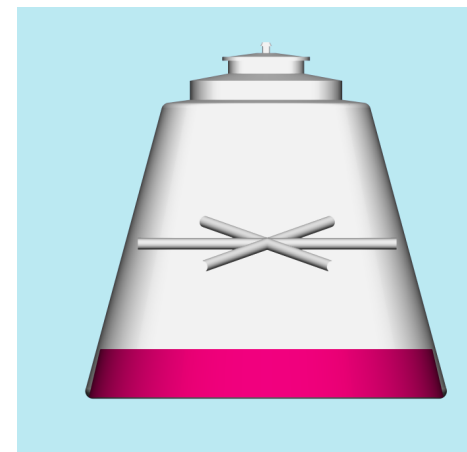

TINOTERMOTANK with PALITANK (DÉLESTAGE)

MAIN FEATURES OF THE FERMENTATION TANK

IDEAL FOR PERFORMING FAST MOIST DÉLESTAGE

- A) during the fermentation of red grapes the natural rise of marc cap is opposed by the conical shape and compacts, staying in contact with the underlying must;
- B) during the délestage the marc cap descends and breaks thanks to PALITANK;
- C) getting down to the bottom, in the widest part of the cone, the marc cap expands and extends: it is therefore possible to perform moist délestage (with some must)
- D) the shape of the tank (the wide side of the cone is at the bottom) helps the cap extension and its wetting in the following phase of must pumping over.

DÉLESTAGE PHASES

TINOTERMOTANK 1st PHASE:

START OF THE FERMENTATION: At the beginning of the fermentation of red grapes the marc cap is spreaded in the must

TINOTERMOTANK 2nd PHASE:

DURING THE FERMENTATION: NATURAL RISING, CONTRAST AND COMPRESSION OF THE MARC CAP: the marc cap keeps moist, staying in contact with the underlying fermenting must

TINOTERMOTANK 3rd PHASE:

FAST MOIST DÉLESTAGE: BREAK OF THE MARC CAP, NATURAL EXPANSION AND EXTENSION OF THE MOIST MARC ON THE BOTTOM

the marc on the bottom breaks and expands, staying slightly moist with must. Thus they naturally and slightly cool down, before the lukewarm or cooled must inlet raises it again. Thereafter the fresh or cool must pumping over causes a thermal shock to the warm marc and raises it; passing through the cap-breaking poles the marc cap breaks and spreads further.

CHIUSURE DI SICUREZZA SAFETY PROTECTIONS

CHIUSURA A DOPPIA GRIGLIA DOUBLE GRID

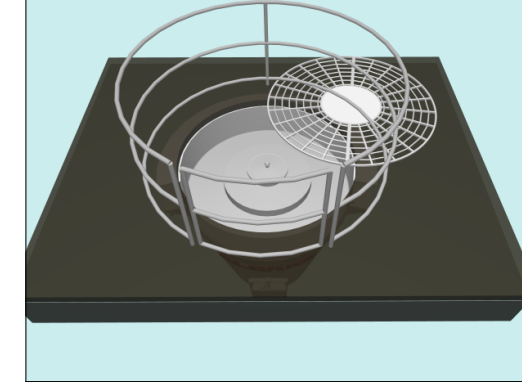
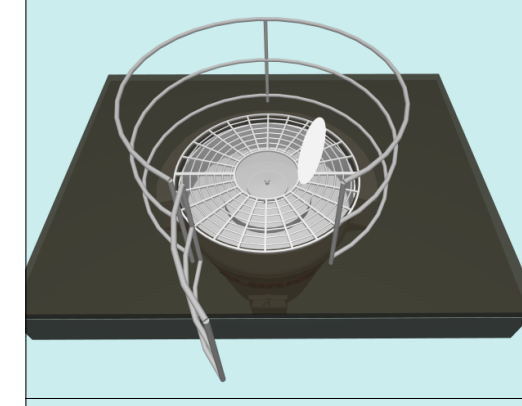
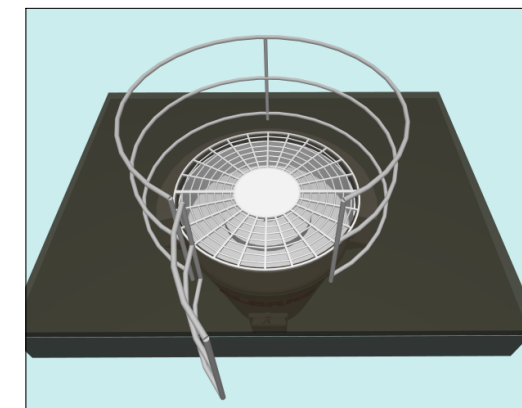

CHIUSURA A DIAFRAMMA DIAPHRAGM PROTECTION

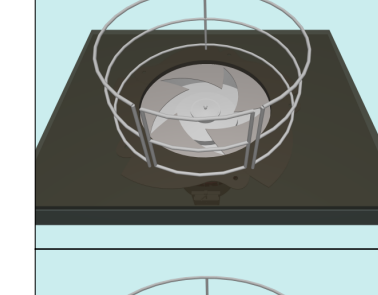
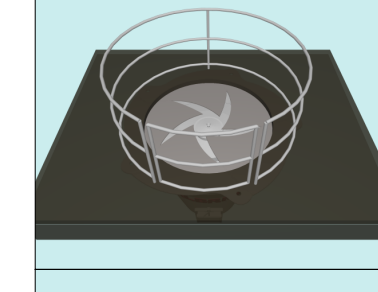
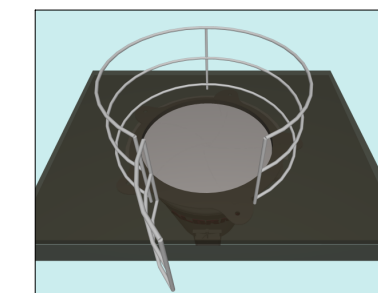

SEPARTANK

decanatore naturale di mosto e separatore di vinacce e vinaccioli
must natural decanter and marc and seeds settling tank

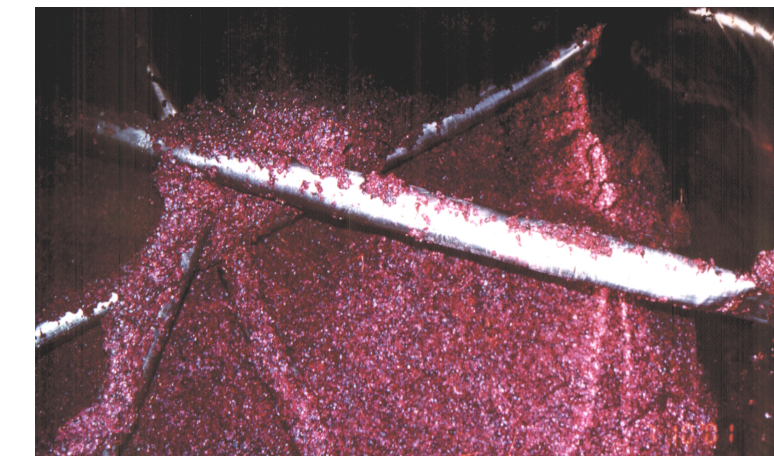
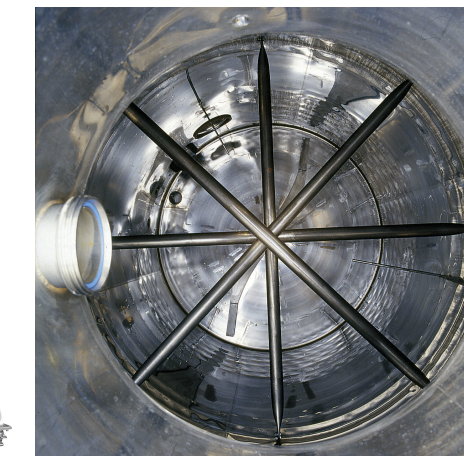

N.B.: I PRESENTI DISEGNI RAPPRESENTANO SOLO UNA PROPOSTA SCHEMATICA, CHE VA VERIFICATA IN OGNI SUA PARTE IN FASE DI PROGETTAZIONE PER INTRODURRE TUTTE LE MODIFICHE EVENTUALMENTE NECESSARIE. TUTTE LE MISURE SONO SOLO INDICATIVE E VANNO VERIFICATE IN LOCO

N.B.: THIS IS ONLY A PRELIMINARY DRAWING, FOR ESTIMATE ONLY, THAT NEEDS TO BE VERIFIED IN EVERY DETAIL DURING THE PROJET, IN ORDER TO INTRODUCE ALL THE NECESSARIES MODIFICATIONS. ALL THE MEASURES ARE APPROXIMATE AND NEED TO BE VERIFIED ON SITE



PLANETARIUS-TINO

DOMANDA DI BREVETTO DEPOSITATA - PATENT PENDING

TAV. 6

INNOTERMOTANK : IL FERMENTATORE IDEALE PER FARE IL DÉLESTAGE MANUALE O AUTOMATICO, LENTO A SECCO

THE IDEAL FERMENTATION TANK FOR MANUAL OR AUTOMATIC, SLOW DRY DÉLESTAGE

INNOTERMOTANK



INNOTERMOTANK-FLY UP



INNOTERMOTANK-FLY UP OFFRE LA POSIZIONE PIU' COMODA PER FARE I CONTROLLI DALL'ALTO DURANTE LA FASE DI FERMENTAZIONE

INNOTERMOTANK-FLY UP OFFERS THE MOST COMFORTABLE POSITION TO MAKE CHECKS FROM ABOVE DURING THE FERMENTATION



INNOTERMOTANK-FLY DOWN

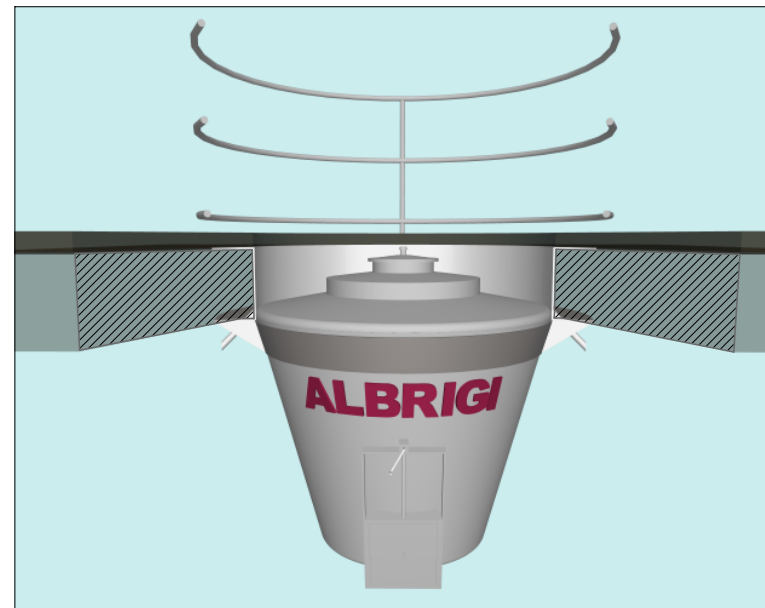
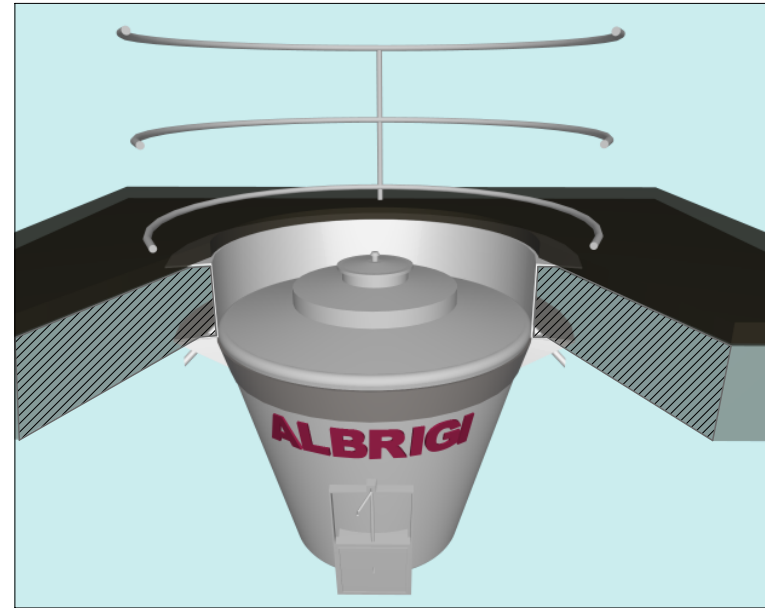

INNOTERMOTANK-FLY DOWN chiuso a collo alto long neck manhole

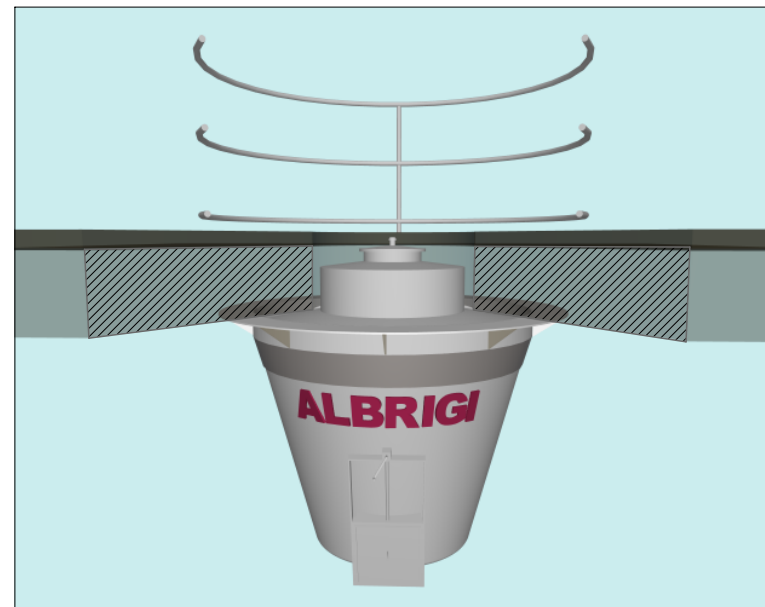
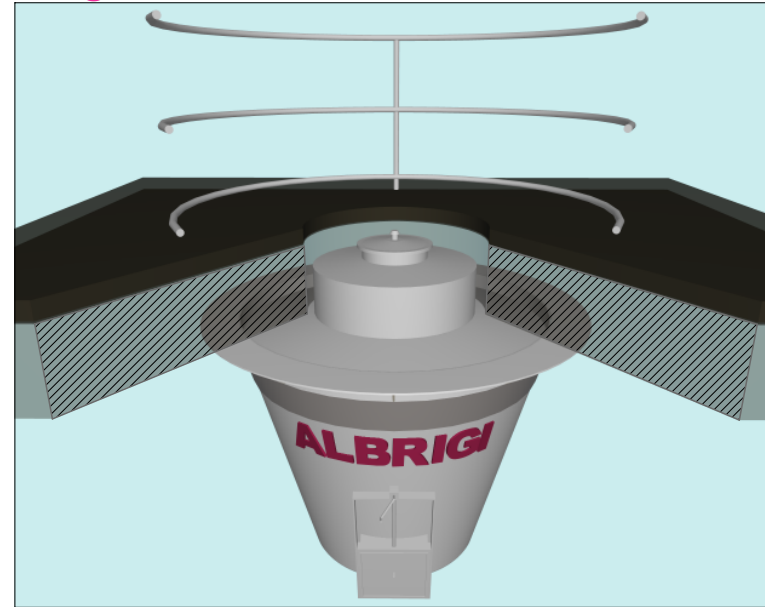

INNOTERMOTANK con PALITANK (DÉLESTAGE)

PRINCIPALI CARATTERISTICHE DEL FERMENTATORE

IDEALE PER FARE IL DÉLESTAGE LUNGO / LENTO A SECCO

- A) durante la fermentazione delle uve rosse il cappello di vinacce è facilitato a salire in modo naturale e continuo, cosicché la vinaccia si distende e si disgrega e il rimontaggio del mosto sul cappello di vinaccia risulta più facile e molto più efficiente;
- B) durante il délestage il cappello di vinaccia scende e grazie a PALITANK si rompe;
- C) arrivando sul fondo, nella parte più stretta del serbatoio, il cappello di vinaccia si compatta, si sprema e si asciuga: si può pertanto fare il délestage a secco (senza mosto);
- D) la sagoma del serbatoio, conica con la parte più stretta in basso, favorisce la raccolta e la concentrazione dei vinaccioli sul fondo.

FASI DEL DÉLESTAGE

INNOTERMOTANK 1° FASE:

INIZIO DELLA FERMENTAZIONE: All'inizio della fermentazione con uve rosse il cappello di vinaccia è sciolto nel mosto

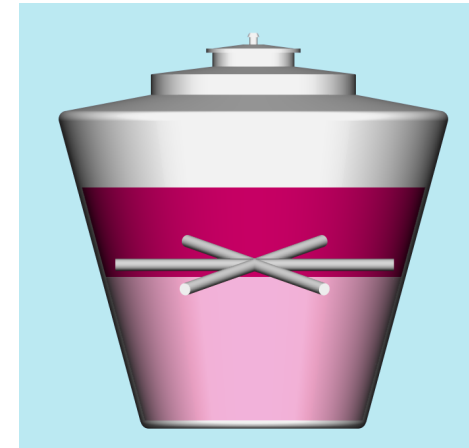

INNOTERMOTANK 2° FASE:

DURANTE LA FERMENTAZIONE: INNALZAMENTO, ALLARGAMENTO, ASSOTTIGLIAMENTO DEL CAPPELLO DI VINACCIA IN MODO NATURALE

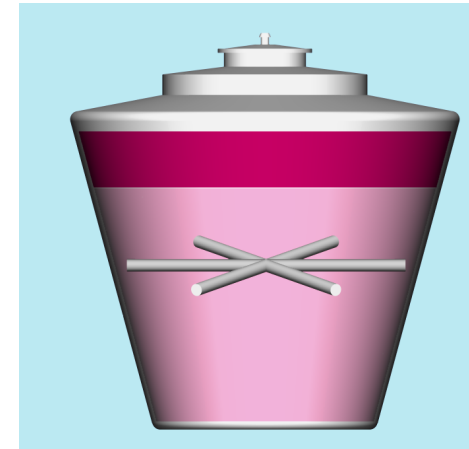

INNOTERMOTANK 3° FASE:

DÉLESTAGE LUNGO-LENTO A SECCO: ROTTURA DEL CAPPELLO DI VINACCIA E CONCENTRAZIONE DI VINACCE SUL FONDO A SECCO, CONCENTRAZIONE DEI VINACCIOLI SUL FONDO, IN MODO NATURALE

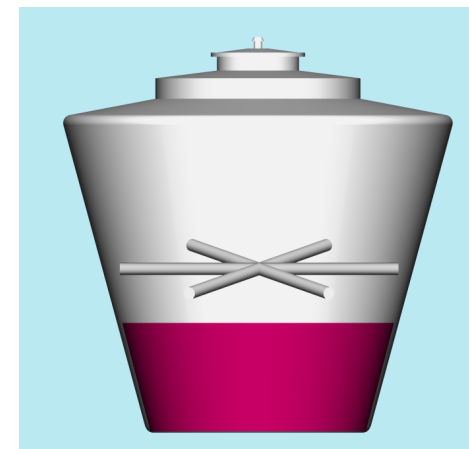

Le vinacce devono riposare sul fondo da 2 a 4 ore con poco mosto, quasi asciutte; qui si riscaldano naturalmente per permettere ad alcuni tipi di lieviti di lavorare a temperatura più elevata.

Successivamente viene rimontato il mosto fresco o raffreddato che provoca uno shock termico sulla vinaccia calda e la fa risalire; ripassando attraverso i pali rompicapello, il cappello di vinaccia si rompe e si disgrega ulteriormente.

SEPARTANK

decantatore naturale di mosto e separatore di vinacce e vinaccioli
must natural decanter and marc and seeds settling tank



INNOTERMOTANK with PALITANK (DÉLESTAGE)

MAIN FEATURES OF THE FERMENTATION TANK

IDEAL FOR PERFORMING LONG / SLOW DRY DÉLESTAGE

- A) during red grapes fermentation the marc cap is helped to rise naturally and continuously, thus the marc expands and expands and breaks naturally and softly, and the must pump over onto the cap gets easier and much more efficient;
- B) during the délestage the marc cap descends and breaks thanks to PALITANK;
- C) getting down to the bottom, in the narrowest part of the cone, the marc cap is compressed, squeezed and gets dry: it is therefore possible to perform dry délestage (without must)
- D) the shape of the tank (the wide side of the cone is at the top) helps the settling and gathering of the seeds on the bottom.

DÉLESTAGE PHASES

INNOTERMOTANK 1st PHASE:

START OF THE FERMENTATION: At the beginning of the fermentation of red grapes the marc cap is spreaded in the must

INNOTERMOTANK 2nd PHASE:

DURING THE FERMENTATION: NATURAL RISING, EXPANSION, THICKNESS REDUCTION OF THE MARC CAP

INNOTERMOTANK 3rd PHASE:

LONG-SLOW DRY DÉLESTAGE : BREAK OF THE MARC CAP AND NATURAL CONCENTRATION AND DRYING OF THE MARC ON THE BOTTOM, CONCENTRATION OF THE SEEDS ON THE BOTTOM

The marc needs to rest 2 to 4 hours on the bottom with a little quantity of must, almost dry; thus they warm up naturally to allows certain kinds of yeast to work at higher temperature. Thereafter the fresh or cool must pumping over causes a thermal shock to the warm marc and raises it; passing through the cap-breaking poles the marc cap breaks and spreads further.

CHIUSURE DI SICUREZZA SAFETY GRIDS

CHIUSURA A DOPPIA GRIGLIA DOUBLE GRID CLOSURE

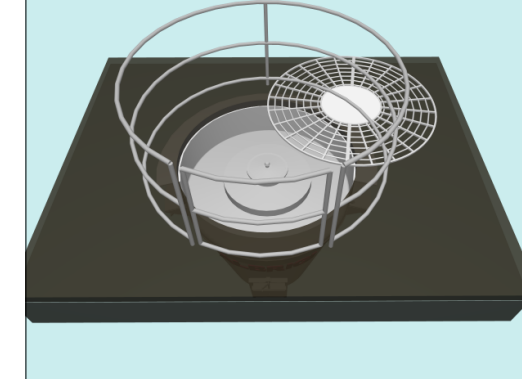
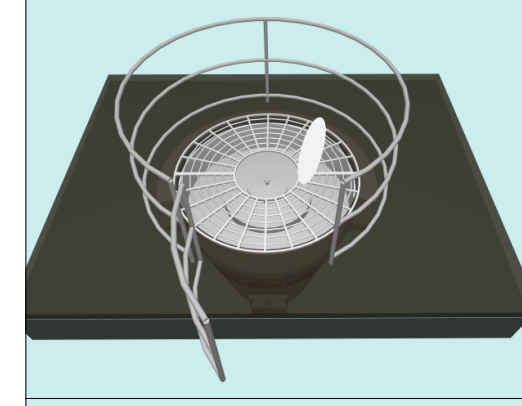
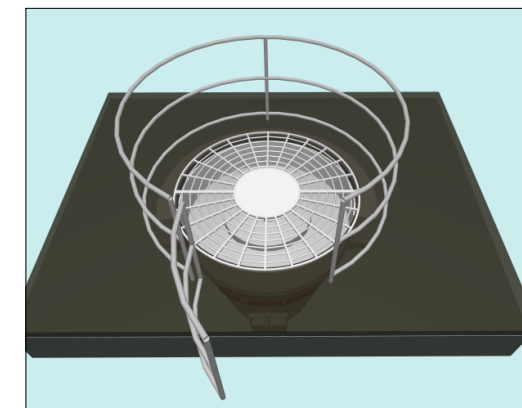

CHIUSURA A DIAFRAMMA DIAPHRAGM CLOSURE

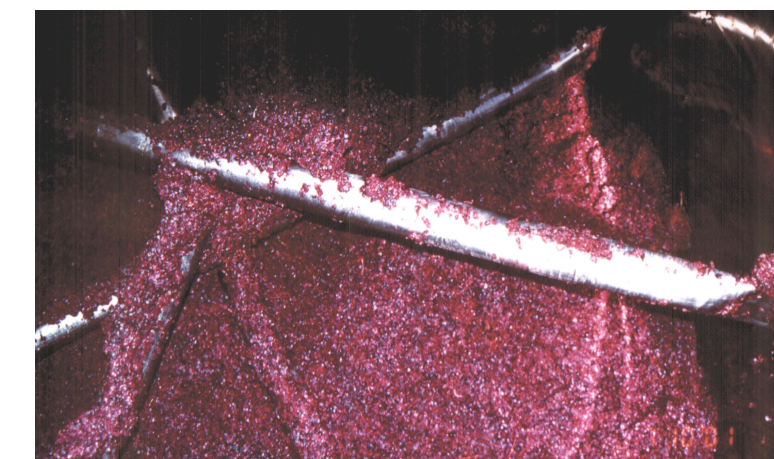
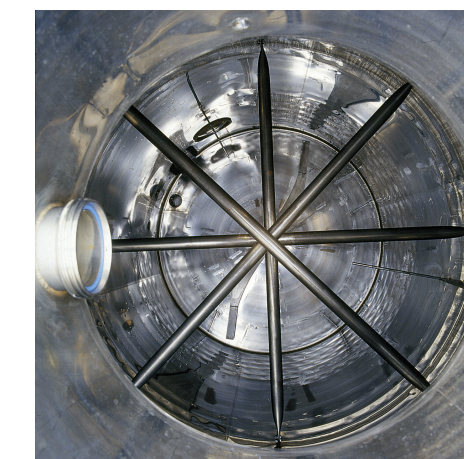
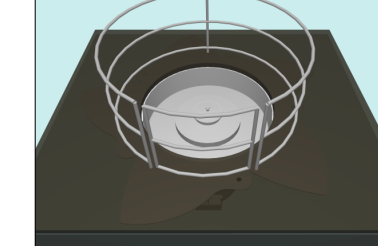
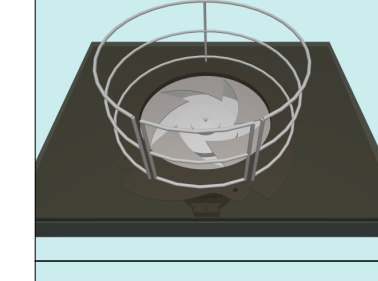
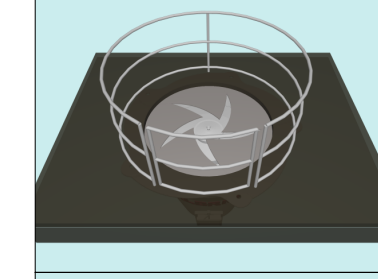
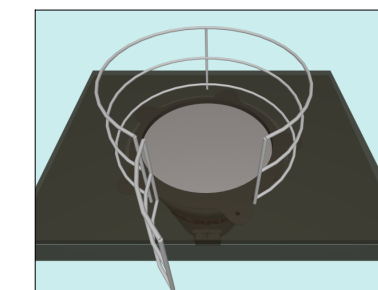

N.B.: I PRESENTI DISEGNI RAPPRESENTANO SOLO UNA PROPOSTA SCHEMATICA, CHE VA VERIFICATA IN OGNI SUA PARTE IN FASE DI PROGETTAZIONE PER INTRODURRE TUTTE LE MODIFICHE EVENTUALMENTE NECESSARIE. TUTTE LE MISURE SONO SOLO INDICATIVE E VANNO VERIFICATE IN LOCO

N.B.: THIS IS ONLY A PRELIMINARY DRAWING, FOR ESTIMATE ONLY, THAT NEEDS TO BE VERIFIED IN EVERY DETAIL DURING THE PROJCT, IN ORDER TO INTRODUCE ALL THE NECESSARIES MODIFICATIONS. ALL THE MEASURES ARE APPROXIMATE AND NEED TO BE VERIFIED ON SITE

PLANETARIUS-INNO

DOMANDA DI BREVETTO DEPOSITATA - PATENT PENDING

TAV. 7

PLANETARIUS[®]

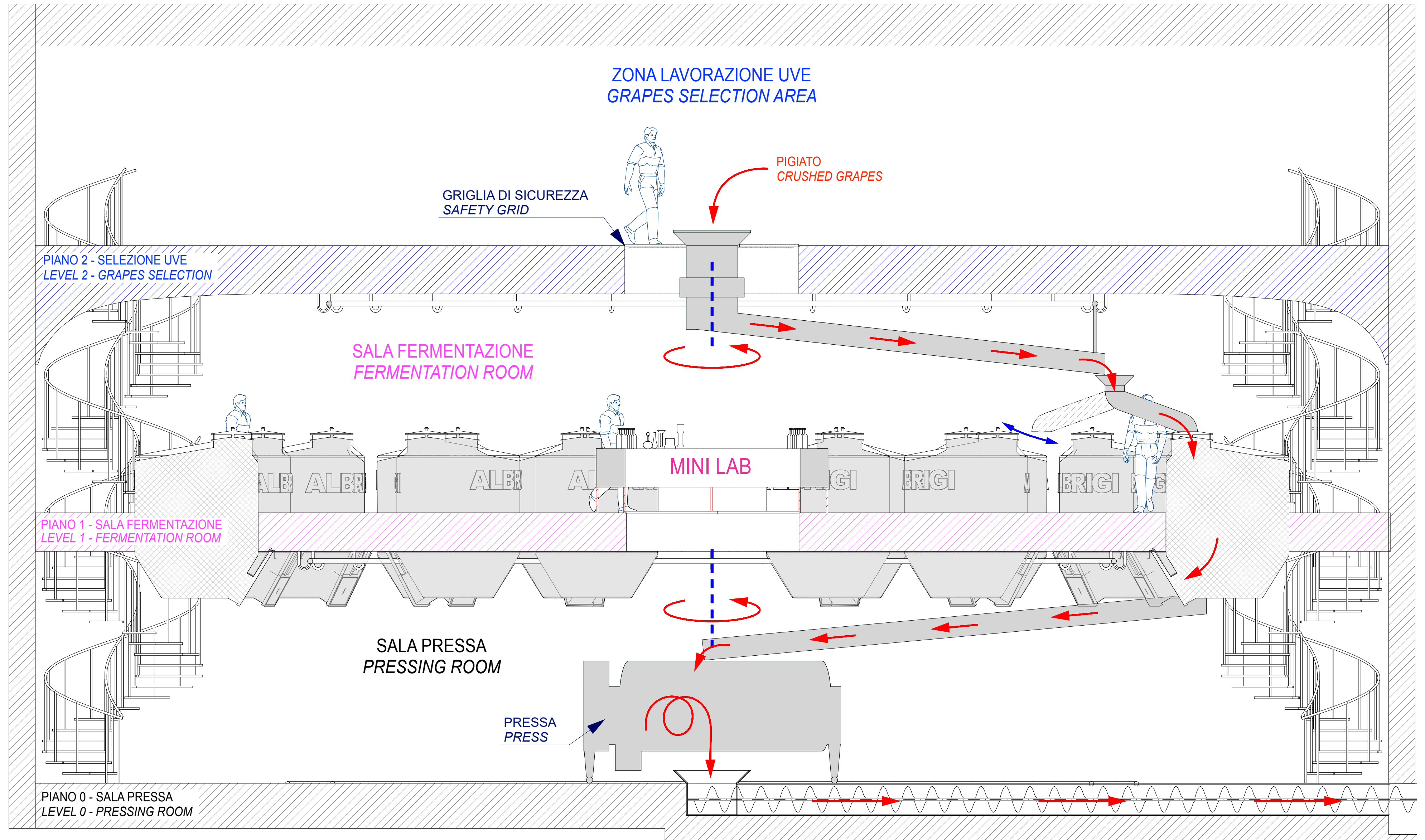

N.B.: I PRESENTI DISEGNI RAPPRESENTANO SOLO UNA PROPOSTA SCHEMATICA, CHE VA VERIFICATA IN OGNI SUA PARTE IN FASE DI PROGETTAZIONE PER INTRODURRE TUTTE LE MODIFICHE EVENTUALMENTE NECESSARIE. TUTTE LE MISURE SONO SOLO INDICATIVE E VANNO VERIFICATE IN LOCO

N.B.: THIS IS ONLY A PRELIMINARY DRAWING, FOR ESTIMATE ONLY. THAT NEEDS TO BE VERIFIED IN EVERY DETAIL DURING THE PROJ. IN ORDER TO INTRODUCE ALL THE NECESSARIES MODIFICATIONS. ALL THE MEASURES ARE APPROXIMATE AND NEED TO BE VERIFIED ON SITE

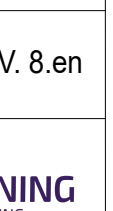
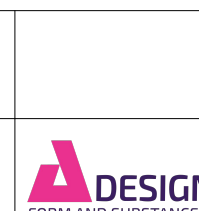

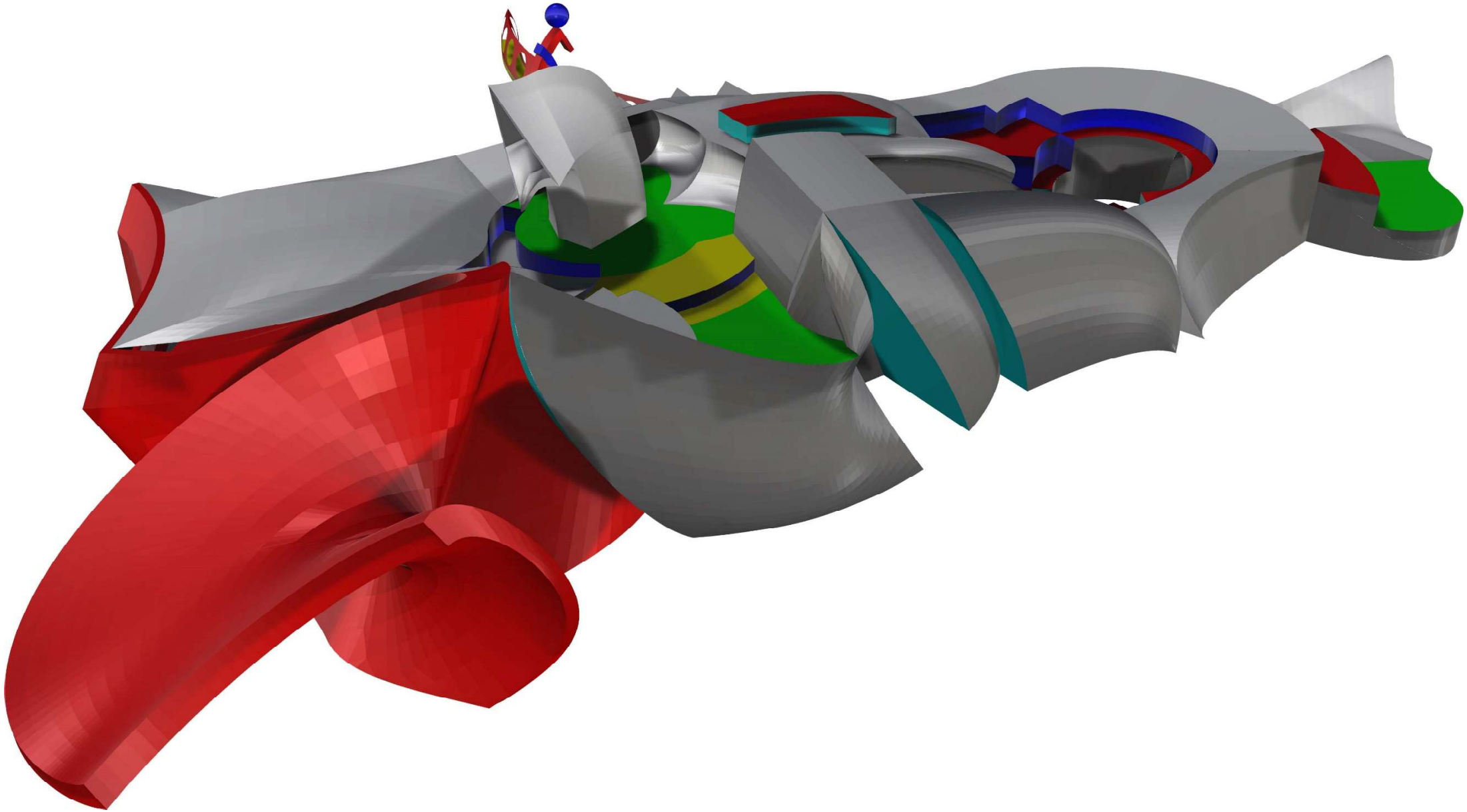

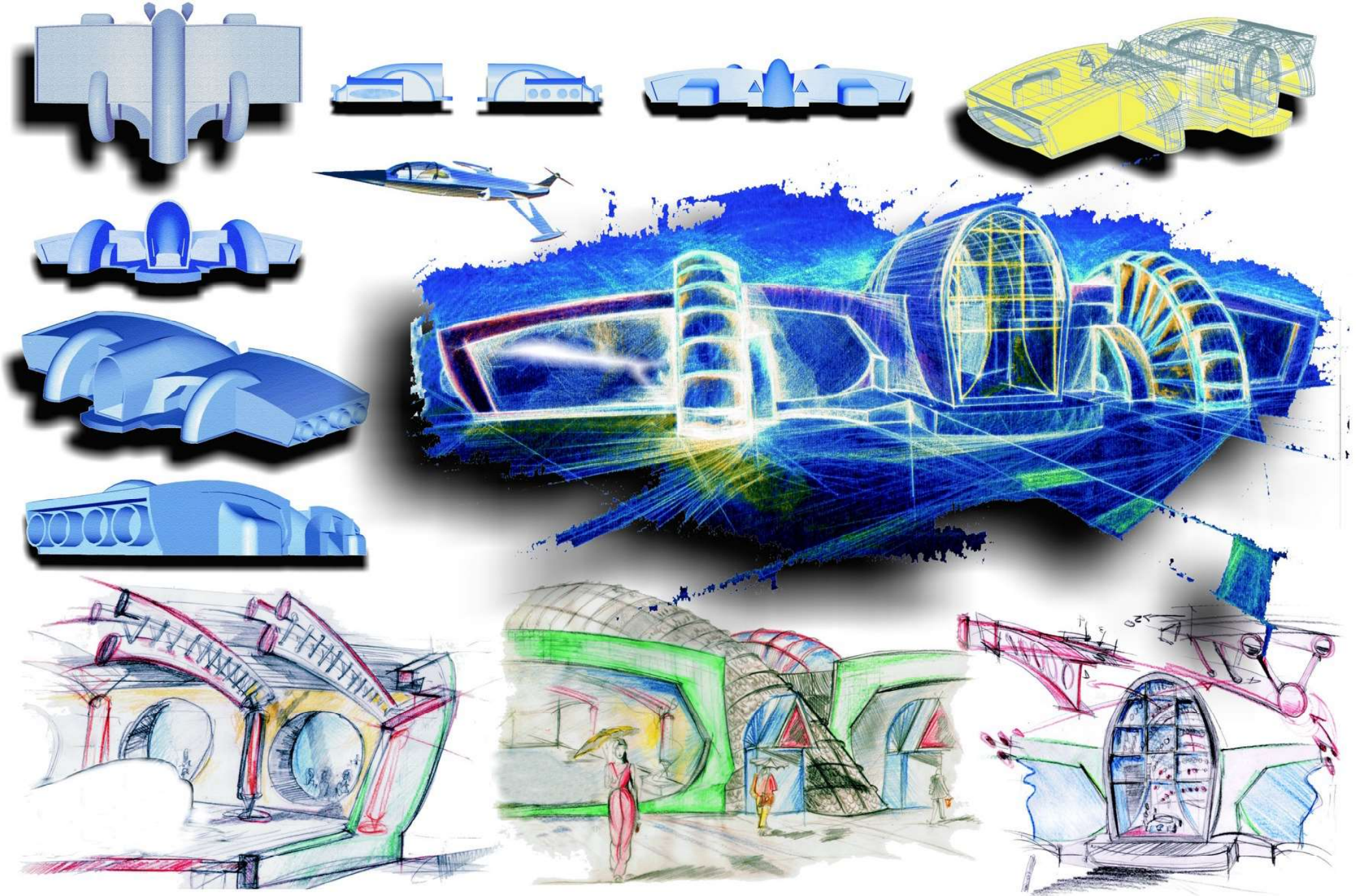

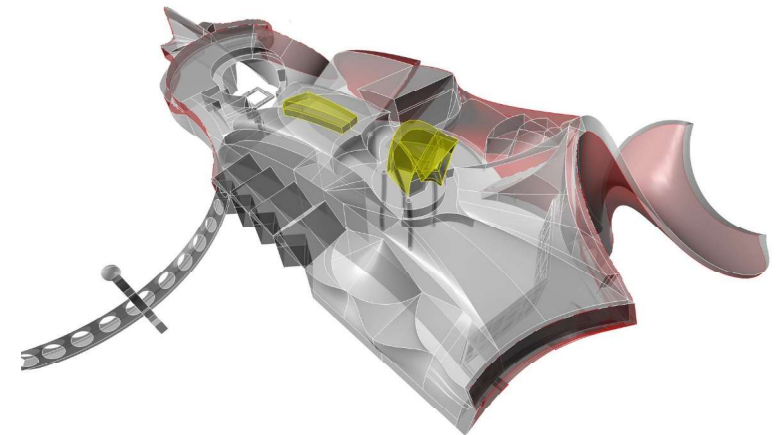
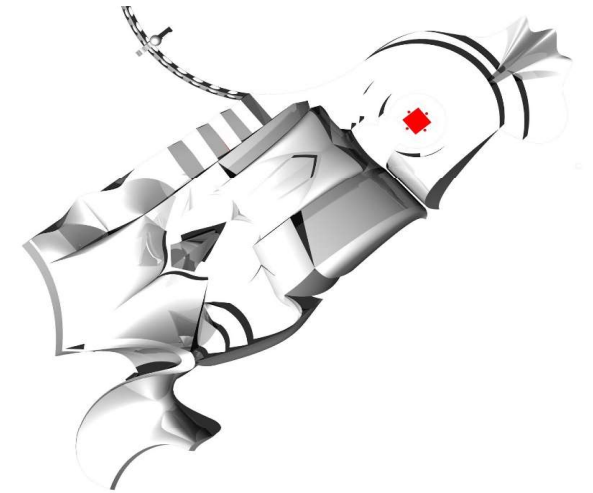
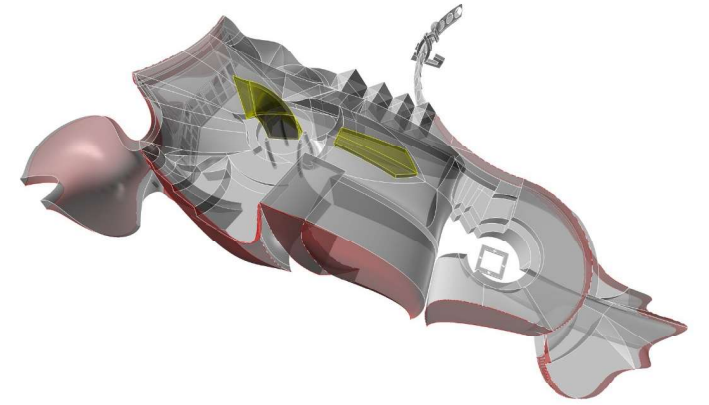



your winery designed by **US**

Since more than 30 years we have been studying fermentation process and designing innovative technologies to develop the natural processes of wine making in accordance with tradition and modern efficiency. We designed and realized the plants to produce the best wines. Our engineers are offering you their experience and knowledge to design the next great winery: **your** winery.

Preliminary visit

Our engineers will visit your company to know your needs and check available spaces, in order propose you the best structure and plant solutions meeting **your specific requirements**.



Consulting

The design is developed with an in-depth study of your requirements, in order to find solutions meaning quality, user friendliness, logistics optimization and rational use of spaces: the union between **right design** and **new technologies**.



Design

Thanks to our thirty years of experience, our engineers will be able to develop the right planning of your project since the design stage, which is a precondition for the installation of the latest **state of the art** technologies.



Manufacturing

We work the best steel with the best tools. Our qualified personnel will follow the development of your project in order to obtain an unique plant, **specifically made for you**.



your winery designed by **US**



A third of a century of evolution

it's a service offered by **Albrigi** Tecnologie

THE NEW WINERY

GENERAL GUIDE LINES ABOUT FACILITIES AND TECHNOLOGIES OF THE WINERY OF THE PRESENT AND THE FUTURE

ALBRIGI TECNOLOGIE IS A PHILOSOPHY

For the last 30 years Albrigi Technologie has been designing and manufacturing wine-making systems for processing both small and large masses of wine, focusing specifically on the development of new technological solutions and on the relentless pursuit of the highest quality. To achieve this Albrigi has established an ongoing collaboration with wine-making experts, agronomists, university professors and, of course, the customers to find the most suitable methods for optimising each single grape type.

Albrigi Technologie offers its customers new fermentation technologies that complement natural and traditional wine-making processes with special emphasis on aspects such as organic production, energy and cost saving measures, and knowing how to make the best use of the internal spaces of a winery.

Today modern wineries can be designed to utilize cutting-edge, eco-sustainable technologies while fully respecting and enhancing the grape and developing traditional processing methods.

For this purpose Albrigi Technologie offers a comprehensive range of machinery and equipment (customizable options available) for every stage of the wine making process starting with the reception of the grapes at the winery, and including fermentation, conditioning, filtration and storage.

Albrigi Technologie systems offer the following 5 advantages:

- time saving (with our technologies the processing stages are fast and efficient),
- temperature control (our systems allow you to control the cold and hot conditioning of the must and wine masses),
- cleanliness (our easy-to-clean plants are eco-friendly as they can be sanitized with little or no cleaning agents),
- automation (use of highly technological systems help the enologist and winery technician perfect performance of the various operations by eliminating errors and loss of time),
- research and experimentation of the various wine-making processes (wines cannot be improved without experimentation and research into wine-making processes). The data [e.g. relating to cultivation of the vineyard, winery operations and the various types of wine produced] is collected and stored using our Archimede data management system, then analysed and transmitted to provide the operator with a record of the wine-making process used for the grapes from each separate vineyard.

Each vintage is unique, each grape variety has its own particular characteristics and properties. Therefore every winery needs a staff of expert technicians that have a thorough understanding of winemaking processes and the available equipment in order to bring out the best in their particular grapes. This ensures that even very large wineries with automated processing and computerised systems for huge masses of grapes are capable of producing top quality wines. On the other hand small to medium sized wineries that produce small or medium sized selected lots of grapes using customised or sophisticated fermentation processes, manage to obtain exclusive and very particular wines of unique taste and refined aromas and consequently to place top quality bottles on the market.

Albrigi's primary aim is to respond to the customer's needs, to understand the type of wine he wants to produce, to propose an ideal process designed specifically for his grapes by identifying the most appropriate equipment that is compatible with the available space, the cost, the time and the personnel engaged by the company during the grape harvest and the subsequent wine processing stage.

Obviously the best results are obtained when the company's wine-making expert has the time to personally follow all the wine-making stages (fermentation, filtration, storage, etc...) or when a PLC is installed in the winery to ensure that the machines punctually perform the required operations programmed by the technician; this means that the winery technician has only to check that all is proceeding according to the enologist's instructions. Unfortunately however, as we are well aware, during the hectic harvesting period the enologist does not have sufficient time to personally oversee the crucial wine-making stages such as pumping over, pigeage, rack-and-return etc. to make sure that they are carried out perfectly; the unexpected is always just around the corner to shift attention to other activities. Moreover, in the later part of the harvesting period, often the parameters of the grapes being processed tend to change according to the time, availability and energy of the people involved in the wine-making process; computer-controlled processes help prevent this situation by punctually adjusting and controlling the wine-making process parameters thereby delegating to staff the sole task of programming and management.

Top quality is like the vertex of a pyramid – you may reach it after a long, complex path made up of many small technological details and processing procedures that combined lead to the achievement of an excellent product.

Albrigi Technologie's primary objective has always been to propose ideas and concepts intended to improve the customer's product by designing and constructing systems that will lead them to the topmost point of the pyramid; otherwise our company, as it stands, would have no reason to exist. Every single day we strive to grow, know, understand and impart to our customers all the know-how that we have built up over thirty years in the business with the collaboration of laboratory technicians, agronomists, researchers, and above all our very own customers who have always provided the input that has stimulated us to produce very special systems.

In this light Albrigi has organized a technical staff capable of offering a comprehensive consultancy service for the design and construction of your winery, covering all aspects from the architectonic concept to the installation of plants and machinery, and encompassing the latest energy saving and renewable energy technologies.

Our modern, natural technologies for quality fermentation of red and white grapes

- A. The quality of the wine starts from the vineyard with the correct cultivation of the vines and making the best use of the natural resources such as soil, air, sun and water;
- B. Grape harvesting is an extremely delicate process whether the grapes are picked into crates, or bins on trailers;
- C. Handling of the grapes during transportation from vineyard to winery is important: time and a cool environment are crucial for the good preservation of the grapes during transit ;
- D. Grape cleaning and selection are fundamental for grading the grapes into first and second choice in order to differentiate production;
- E. Management of the destemming and crushing stages is important to ensure that the must and crushed grapes respond to your requirements;
- F. The fermentation stage must be examined and planned according to the type of grape to be processed (e.g. if hard or soft skin variety, if the grape gives more or less intense colour to the wine, etc...);
- G. We recommend a specific type of fermentor and a well-defined fermentation process for each grape variety;
- H. We separate white and red grape varieties;
- I. For white grapes without skins we recommend cryo-maceration, cold clarification, bâtonnage;
- L. We recommend 6 different technologies for the fermentation of red grapes with skins, depending on whether the skin is hard or soft, whether large or small masses are to be processed, how much height and width space is available, how much time is available to carry out all the operations. They are:
 - a. Rack and return
 - b. Rotating disk fermentor
 - c. Punching down
 - d. Cascade fermentation
 - e. Turbine
 - f. Submerged cap fermentation

Each fermentation process requires the implementation of a number of specific measures to ensure that the process is truly effective. Our experience in this regard and our technicians are at the complete disposal of customers, enologists and winery technicians to transfer the know-how we have accumulated over years of analyses, research and experimentation on many different grape varieties, and thanks to which we are capable of obtaining impressive yield and quality from each single process and type of fermentor.

Nowadays a company like ours, that aims to achieve the best quality, must ensure that customers have access to all available information to enable them to take full advantage of our systems and our equipment for the production of great wines in as short a time as possible, without wasting time and energy.

Only in this way can Albrigi Technologie be considered "ahead of its time" !

INDEX

1. FACILITIES FOR THE WINERY	7
1.1 WASTE WATERS (EQUIPMENTS AND FLOOR WASHING WATERS, VINIFICATION WASTES)	
1.2 ELECTRIC SYSTEM	7
1.2.1 BARREL ROOM.....	7
1.2.2 “FRUTTAIO”	7
1.2.3 PRESSING ROOM.....	7
1.2.4 WEIGHING AND GRAPES SAMPLING.....	7
1.2.5 FERMENTATION ROOM: musts and pressed grapes treatment.....	7
1.2.6 WINE STORAGE ROOM: wine-working room	8
1.2.7 BOTTLING ROOM.....	8
1.2.8 EMPTY BOTTLES STORAGE.....	2 8
1.2.9 CARTONS, LABELS, CORKS, GLUES WAREHOUSE.....	8
1.2.10 FULL BOTTLES WAREHOUSE	8
1.2.11 ELECTRIC POWER ROOM	8
1.3 COOLING SYSTEM.....	9
1.4 CONDITIONING SYSTEM.....	9
1.5 HEATING SYSTEM (BOILER)	9
1.6 STEAM PRODUCTION SYSTEM (STEAM BOILER).....	9
1.7 WASHING SYSTEM.....	9
1.8 COMPRESSED AIR SYSTEM.....	9
1.9 NITROGEN GENERATOR	9
1.10 DRY ICE.....	9
1.11 WATER SYSTEM.....	9
1.12 HIGH PRESSURE WATER SYSTEM.....	9
1.13 HIGH PRESSURE PIPELINES FOR CLEANER.....	9
1.14 CO ₂ SUCTION.....	9
1.15 VIDEO SURVEILLANCE	10
1.16 FILTRATION ROOM.....	10
1.17 FIXED STAINLESS STEEL PIPELINES	10
1.18 DATA SYSTEM “ARCHIMEDE”	10

2. FACILITES FOR EACH DEPARTMENT	13
2.1 PRESSING ROOM:.....	13
2.2 FRUTTAIO:.....	13
2.3 FERMENTATION ROOM:.....	13
2.4 STORAGE ROOM:.....	13
2.5 BARREL ROOM:	13
2.6 TARTRATE STABILIZATION	13
2.7 FILTRATION:	13
2.8 EMPTY BOTTLES WAREHOUSE	13
2.9 BOTTLING ROOM:	13
2.10 FULL BOTTLES WAREHOUSE.....	13
2.11 CARTONS, LABELS, CORKS, GLUES WAREHOUSE.....	13



ALBRIGI
TECNOLOGIE
A third of a century of evolution

1. FACILITIES FOR THE WINERY

1.1 WASTE WATERS (equipments and floor washing waters, vinification wastes)

- ducts, manholes and wells in every department;
- suction pumps for suction of waste waters from wells to the waste waters collecting tank;
- waste waters collecting tank (the tanks can be differentiated for each kind of product or waste);
- suction pumps for suction of waste waters to empty the collecting tank (e.g. to the tanktruck);
- electric system for suction pumps.

1.2 ELECTRIC SYSTEM

1.2.1 BARREL ROOM

- 1 electric panel every 20 m with 3 sockets (380 V, 220 V, 24 V), placed on the ways and in places free from the wooden barrels;
- led lighting system, to avoid introducing heating sources, with possibility of changing brightness and colour of the light (bright and strong light for working, dark and warm light for visits);
- emergency lighting system;
- suction system for CO₂ in the stagnation points of the barrel room, with automatic alarms station;
- suction pumps system for suction of waste waters from wells;
- data system with several connecting points;
- intercom system with several connecting points;
- electric system dedicated to micro-oxygenation system;
- fire extinguishing system;
- conditioning and humidification system to keep the right climate for the rest of wooden barrels (humidification and steaming).

1.2.2 “FRUTTAIO”

- 1 electric panel every 20 m with 3 sockets (380 V, 220 V, 24 V), placed on the passage ways and in places free from the boxes of grapes rest;
- led lighting system, to avoid introducing heating sources, with possibility of changing brightness and colour of the light (bright and strong light for working, dark and warm light for visits);
- emergency lighting system;
- automatic windows opening and closing;
- control station for hygrometric conditions and fanning;
- suction pumps system for suction of waste waters from wells;
- data system with several connecting points;
- intercom system with several connecting points;
- fire extinguishing system;
- air recirculation and drying system to dry up the grapes.

N.B.: Since the “Fruttaiio” is a wide room, available for about 8 months a year, (if it’s not used as warehouse for empty boxes), it can be used as meeting-hall or dinig-hall; in this case you should arrange:

- wide stairs,
- toilettes,
- lifts,
- lighting system,
- emergency doors,
- air-heating/cooling system, designed for the right number of guests,
- fire extinguishing system, designed for the right number of guests ,
- wardrobe,
- kitchen,
- multimedia system,
- amplifier system,
- direction room,
- interpreters room,
- simultaneous translation circuit,
- etc.

1.2.3 PRESSING ROOM

- general electric panel, from which the fixed electric lines dedicated to pressing machines start (1 grapes collection tank, 1 grapes crusher, 1 marcs pump, 1 wine-press);
- neon lighting system to optimize visibility for workers;
- emergency lighting system;
- suction pumps system for suction of waste waters from wells;
- data system with several connecting points;
- intercom system with several connecting points;
- fire extinguishing system;
- earth system for every machine and tank.

1.2.4 WEIGHING AND GRAPES SAMPLING

- weighing management room;
- grapes sampling machine;
- data system;
- intercom system.

1.2.5 FERMENTATION ROOM: musts and pressed grapes treatment

- wall general electric power panel, from which fixed electric lines dedicated to fermentation tanks engines start (marc extractors, fixed pumps for fermentation tanks etc.);

- 1 electric panel every 20 m with 3 sockets (380 V, 220 V, 24 V), placed on the ways and in places free from tanks;
- suction system for CO₂ in the stagnation points of the fermentation room, with automatic signalling station;
- neon lighting system to optimize visibility for workers;
- emergency lighting system;
- fire extinguishing system;
- suction pumps system for suction of waste waters from wells;
- data system with several connecting points;
- intercom system with several connecting points;
- electric system for tank jackets conditioning (warm and cold) during the fermentation;
- micro and macro-oxygenation system;
- earth system for every machine and tank.

1.2.6 WINE STORAGE ROOM: wine-working room

- general electric power panel, from which fixed electric lines dedicated to wine fixed filters start;
- 1 electric panel every 20 m with 3 sockets (380 V, 220 V, 24 V), placed on the passage ways and in places free from tanks, dedicated to decanting pumps and mobile mass mixers;
- suction system for CO₂ in the stagnation points of the storage room, with automatic signalling station;
- neon lighting system to optimize visibility for workers;
- emergency lighting system;
- fire extinguishing system;
- suction pumps system for suction of waste waters from wells;
- data system with several connecting points;
- intercom system with several connecting points;
- electric system for tank jackets conditioning (warm and cold) during the storage of wine;
- earth system for every machine and tank.

1.2.7 BOTTLING ROOM

- wide cabinet general electric power panel, placed in an easily accessible place, with 10-15 fixed electric lines dedicated to bottling machines;
- 1 electric panel every 20 m with 3 sockets (380 V, 220 V, 24 V), placed on the ways and in places free from tanks, dedicated to pumps, cleaning machines etc.;
- neon lighting system to optimize visibility for workers;
- emergency lighting system;
- fire extinguishing system;
- suction pumps system for suction of waste waters from wells;
- data system with several connecting points;
- intercom system with several connecting points;
- conditioning system;
- air filtration system;
- automatic open/close system for doors, for the passage of forklifts;
- earth system for every machine and tank.

1.2.8 EMPTY BOTTLES STORAGE

- electric panels with 3 sockets (380 V, 220 V, 24 V);
- neon lighting system to optimize visibility for workers;

- emergency lighting system;
- data system with several connecting points;
- intercom system with several connecting points;
- fire extinguishing system;
- battery charger for forklifts (outdoor);
- automatic open/close system for doors, for the passage of forklifts;
- earth system for every machine.

1.2.9 CARTONS, LABELS, CORKS, GLUES WAREHOUSE

- electric panels with 3 sockets (380 V, 220 V, 24 V);
- neon lighting system to optimize visibility for workers;
- emergency lighting system;
- data system with several connecting points;
- intercom system with several connecting points;
- fire extinguishing system;
- air drying system;

1.2.10 FULL BOTTLES WAREHOUSE

- electric panels with 3 sockets (380 V, 220 V, 24 V);
- neon lighting system to optimize visibility for workers;
- emergency lighting system;
- data system with several connecting points;
- intercom system with several connecting points;
- fire extinguishing system;
- air conditioning and drying system (steady temperature 14°C);
- automatic open/close system for doors, for the passage of forklifts;
- electric lift;
- battery charger for forklifts (outdoor);

1.2.11 ELECTRIC POWER ROOM

- electric transformer and safety system;
- electric panels with 3 sockets (380 V, 220 V, 24 V);
- neon lighting system to optimize visibility for workers;
- emergency lighting system;
- data system with several connecting points;
- UPS (uninterrupted power supply) for computers network and PLC equipped machines;
- photovoltaic panels electric lines (inverter, batteries ...);
- 1 electric line for 1st underground floor;
- 1 electric line for 2nd underground floor;
- 1 electric line for fruitaio;
- 1 electric line for pressing room;
- 1 electric line for wine storage room;
- 1 electric line for fermentation room;
- 1 electric line for bottling room;
- 1 electric line for every floor lighting system;
- 1 electric line for emergency lighting;

- 1 electric line for waste water wells pump;
- 1 electric line for fire extinguishing system;
- 1 electric line for car parking lighting;
- 1 electric line for parc;
- 1 electric line for lifts;
- 1 electric line for house etc.;
- 1 electric line for offices;

1.3 COOLING SYSTEM

- storage room: tank jackets conditioning;
- fermentation room: warm/cool tank jackets conditioning;
- full bottles warehouse: air-conditioning and drying system;
- bottling room: air-conditioning;
- offices and house: air-conditioning.

1.4 CONDITIONING SYSTEM

THERMAL UNIT:

- water supplies;
- water autoclave pumps;
- water treatment;
- boiler;
- steam production facilities;
- compressed air system;
- nitrogen supply system;
- cooling unit;
- cleaning CIP;
- pressured water system.

1.5 HEATING SYSTEM (boiler)

- fermentation room: warm/cool tank jackets conditioning;
- bottling room: air-conditioning;
- offices and house: air-conditioning.
- wash water for tanks, machines, floors.

1.6 STEAM PRODUCTION SYSTEM (steam boiler)

In the following departments:

- storage room: tanks and floor washing;
- fermentation room: tanks and floor washing;
- filtration room: machines and floor washing;
- bottling room: machines and floor washing;
- humidification in barrel room with spray injector.

1.7 WASHING SYSTEM

- washing CIP connected to the hot water low pressure or high pressure circuit.

1.8 COMPRESSED AIR SYSTEM

- micro and macro oxygenation;
- pressing room;
- bottling room (for every machine);
- pneumatic valve control for liquids transfer;
- biological depuration system.

1.9 NITROGEN GENERATOR

In the following departments:

- barrel room: for wine decanting;
- storage room: to inactitanke wine tanks and wine decanting;
- pressing room: to decant musts and pressed grapes in inactive atmosphere;
- bottling room: for decanting, filtering and inactitankion of full bottles;
- filtration: for wine transfer.

1.10 DRY ICE

- to keep cool grapes picked with grape-gatherer machine from the vineyard to the winery

1.11 WATER SYSTEM

- pipelines for cool filtered water;
- pipelines for hot filtered wash water;

1.12 HIGH PRESSURE WATER SYSTEM

- water compressor for production of cool or hot high pressure water;

1.13 HIGH PRESSURE PIPELINES FOR CLEANER

- pipelines for high pressure hot wash water;
- pipelines for high pressure cool wash water;

1.14 CO₂ SUCTION

In the following departments:

- fermentation room;



ALBRIGI
TECNOLOGIE

A third of a century of evolution

- pressing room;
- storage room.

1.15 VIDEO SURVEILLANCE

- thief-proof and accesses control outdoor cameras (high definition digital cameras, with motion/noise detection system and automatic recording start, with remote control via internet, with infrared night lighting);
- indoor cameras in each department for inspection and thief-proof control;
- NAS recording with automatic overwriting.

1.16 FILTRATION ROOM

- warm water;
- cold water;
- nitrogen.

1.17 FIXED STAINLESS STEEL PIPELINES

- warm water;
- cold water;
- nitrogen.

1.18 DATA SYSTEM “ARCHIMEDE”

- trough “Archimede” you can control the activities in each department and winemaking process;
- data monitoring stations and data managing panels for workers are installed in each department (office, fruttaiolo, barrel room, vineyard, fermentation room etc.);
- Archimede can process and manage many different datas, listed in detail in the following features card.



2. FACILITIES FOR EACH DEPARTMENT

2.1 PRESSING ROOM:

- power supply;
- hot water;
- cold water;
- high pressure hot water
- high pressure cold water;
- nitrogen;
- waste waters collecting ducts;
- grape-stalk discharge;
- marcs storage;
- CO₂ suction;
- compressed air;
- data system;
- stainless steel pipelines for marcs and musts decanting.

2.2 FRUTTAIO:

- power supply;
- hot water;
- cold water;
- high pressure hot water
- high pressure cold water;
- air drying system;
- air conditioning;
- waste waters collecting ducts;
- data system;
- ducts for grapes transfer to the pressing room;

2.3 FERMENTATION ROOM:

- power supply;
- hot water;
- cold water;
- high pressure hot water
- high pressure cold water;
- steam;
- waste waters collecting ducts;

- grape-stalk discharge;
- lees discharge;
- CO₂ suction;
- compressed air;
- cold water for tank jackets;
- hot water for tank jackets;
- grape-stone regeneration;
- data system;
- micro and macro-oxygenation system;
- stainless steel pipelines for marcs and musts decanting.

2.4 STORAGE ROOM:

- power supply;
- hot water;
- cold water;
- high pressure hot water
- high pressure cold water;
- steam;
- nitrogen;
- waste waters collecting ducts;
- grape-stalk discharge;
- CO₂ suction;
- compressed air;
- cold water for tank jackets;
- hot water for tank jackets;
- data system;
- micro and macro-oxygenation system;
- stainless steel pipelines for wines decanting.

2.5 BARREL ROOM:

- power supply;
- hot water;
- cold water;
- high pressure hot water
- high pressure cold water;
- steam;
- nitrogen;

- humidification;
- air conditioning;
- waste waters collecting ducts;
- grape-stalk discharge;
- CO₂ suction;
- compressed air;
- data system;
- micro and macro-oxygenation system;
- stainless steel pipelines for wines decanting.

2.6 TARTRATE STABILIZATION

- power supply;
- hot water;
- cold water;
- high pressure hot water
- high pressure cold water;
- steam;
- nitrogen;
- waste waters collecting ducts;
- grape-stalk discharge;
- glycol liquid at -10°C for tartrate stabilization;
- data system;
- stainless steel pipelines for wines decanting.

2.7 FILTRATION:

- power supply;
- hot water;
- cold water;
- high pressure hot water
- high pressure cold water;
- steam;
- nitrogen;
- waste waters collecting ducts;
- discharge of filtration wastes;
- compressed air;
- data system;
- stainless steel pipelines for wines decanting.

2.8 EMPTY BOTTLES WAREHOUSE

- power supply;
- data system;

2.9 BOTTLING ROOM:

- power supply;
- hot water;
- cold water;
- high pressure hot water
- high pressure cold water;
- steam;
- air conditioning;
- air filtration;
- nitrogen;
- waste waters collecting ducts;
- compressed air;
- data system;

2.10 FULL BOTTLES WAREHOUSE

- power supply;
- air conditioning and drying;
- data system;

2.11 CARTONS, LABELS, CORKS, GLUES WAREHOUSE

- power supply;
- air conditioning and drying;
- data system;

ROOF PLAN

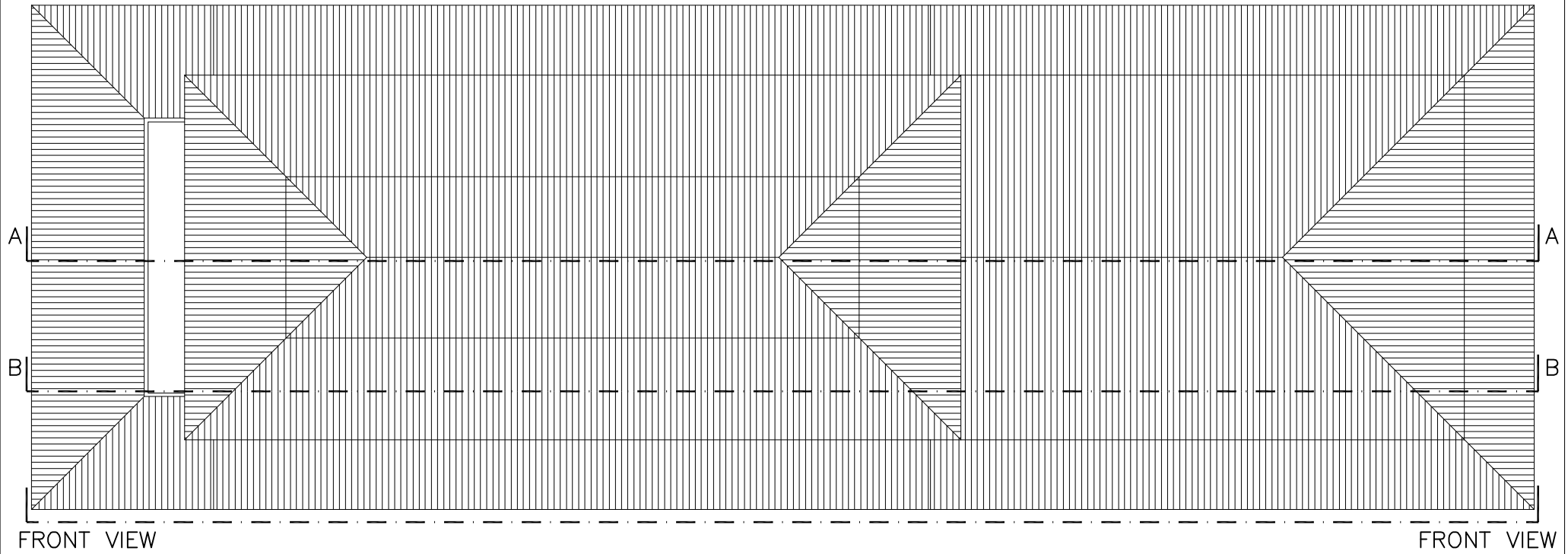

FRONT VIEW

FRONT VIEW

FRONT VIEW

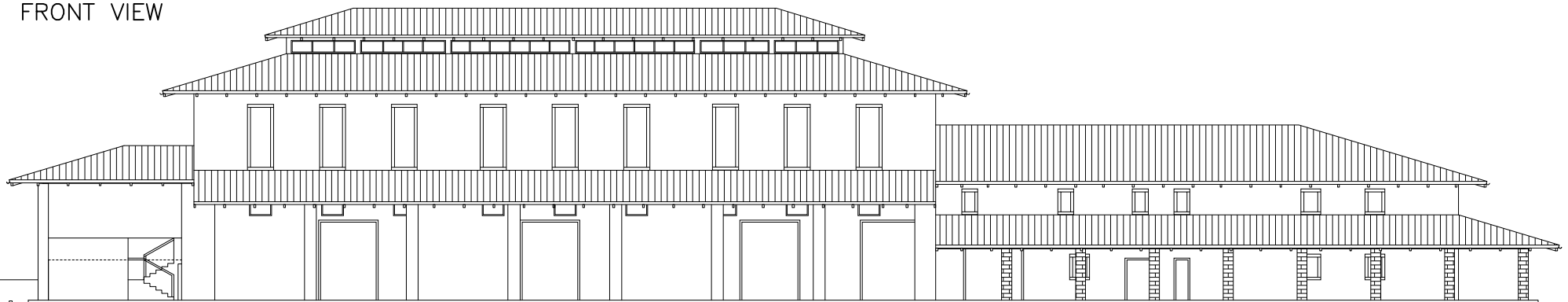

PROGETTO-DESIGN
WINERY FOR GRAPES DRYING, WINE-MAKING,
WINE AGING IN BARRELS, BOTTLING AND WINE SELLING

DESCRIZIONE-DESCRIPTION
PIANTA COPERTURA

ALBRIGI S.R.L.	CODICE-CODE	T-6	SCALA-SCALE	1:200
	REV.	0	DATA-DATE	FEB-2011

Questo disegno è di proprietà della ditta ALBRIGI srl non può essere riprodotto o ceduto senza autorizzazione scritta
This drawing is property of ALBRIGI srl and may not be reproduced nor handed to third parties without a specific authorization from ALBRIGI srl

SECTION A -A

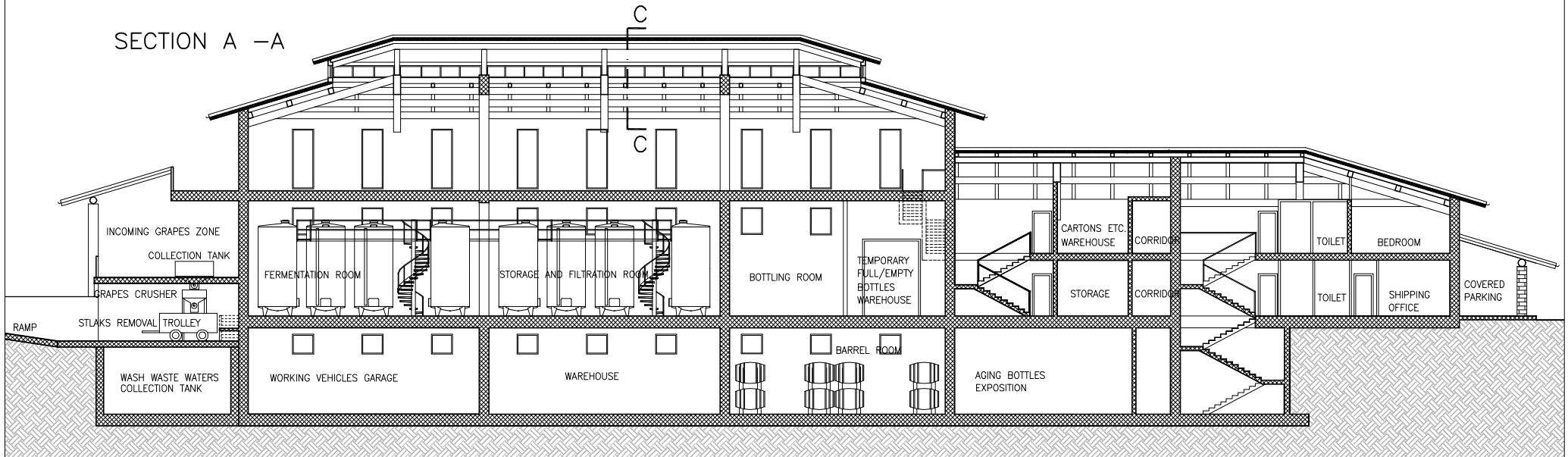

SECTION B-B

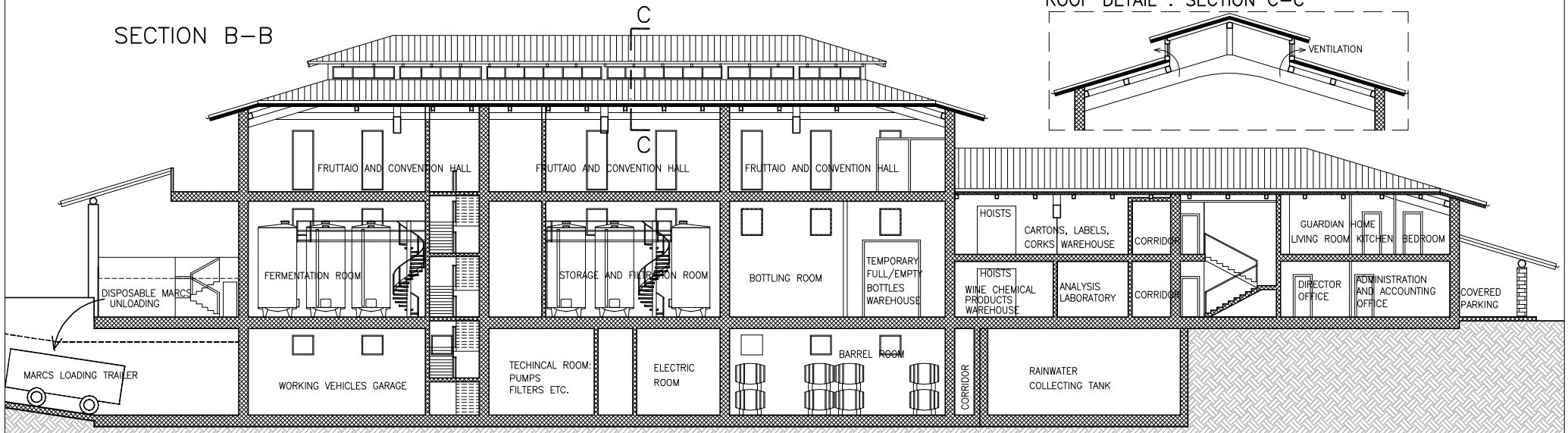

ROOF DETAIL : SECTION C-C

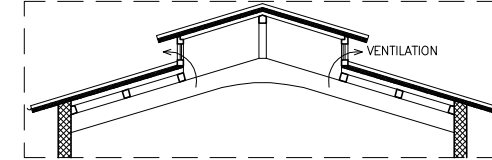

PROGETTO-DESIGN
**WINERY FOR GRAPES DRYING, WINE-MAKING,
 WINE AGING IN BARRELS, BOTTLING AND WINE SELLING**

DESCRIZIONE-DESCRIPTION
SEZIONI

ALBRIGI S.R.L.	CODICE-CODE	T-7	SCALA-SCALE	1:200
	REV.	0	DATA-DATE	FEB-2011

Questo disegno è di proprietà della ditta ALBRIGI srl, non può essere riprodotto o ceduto senza autorizzazione scritta.
 This drawing is property of ALBRIGI srl and may not be reproduced nor handed to third parties without a specific authorization from ALBRIGI srl

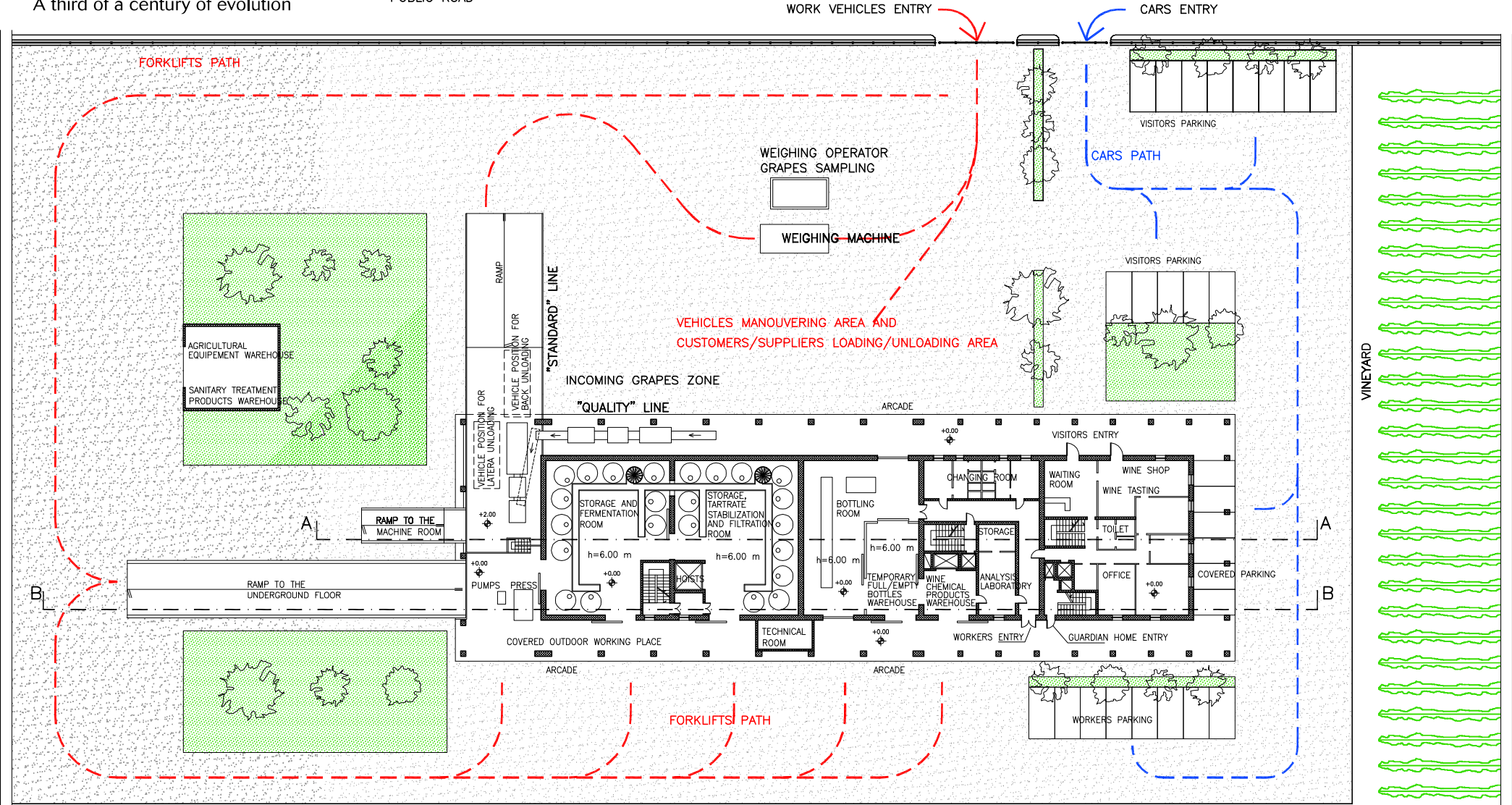

GROUND FLOOR GENERAL PLAN

PROGETTO-DESIGN
WINERY FOR GRAPES DRYING, WINE-MAKING,
WINE AGING IN BARRELS, BOTTLING AND WINE SELLING

DESCRIZIONE-DESCRIPTION
PIANTA GENERALE PIANO TERRA

	CODICE-CODE	T-1	SCALA-SCALE	-
	REV.	0	DATA-DATE	FEB-2011

Questo disegno è di proprietà della ditta ALBRIGI srl non può essere riprodotto o ceduto senza autorizzazione scritta.
This drawing is property of ALBRIGI srl and may not be reproduced nor handed to third parties without a specific authorization from ALBRIGI srl

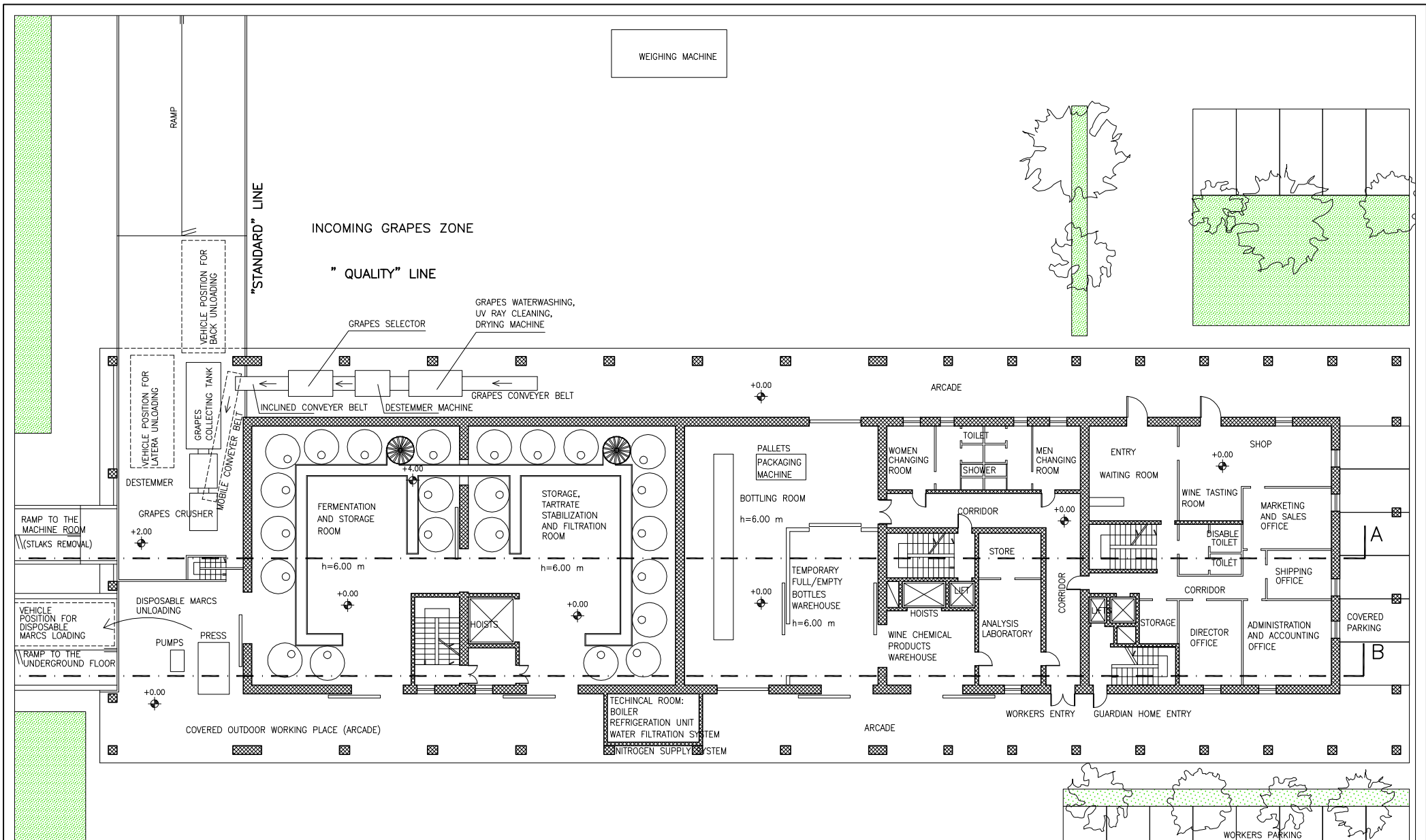

GROUND FLOOR PLAN
ELEVATION +0.00m



PROGETTO-DESIGN
WINERY FOR GRAPES DRYING, WINE-MAKING,
WINE AGING IN BARRELS, BOTTLING AND WINE SELLING

DESCRIZIONE-DESCRIPTION
PIANTA PIANO TERRA

	CODICE-CODE	T-2	SCALA-SCALE	1:200
	REV.	0	DATA-DATE	FEB-2011

Questo disegno è di proprietà della ditta ALBRIGI srl, non può essere riprodotto o ceduto senza autorizzazione scritta.
This drawing is property of ALBRIGI srl and may not be reproduced nor handed to third parties without a specific authorization from ALBRIGI srl

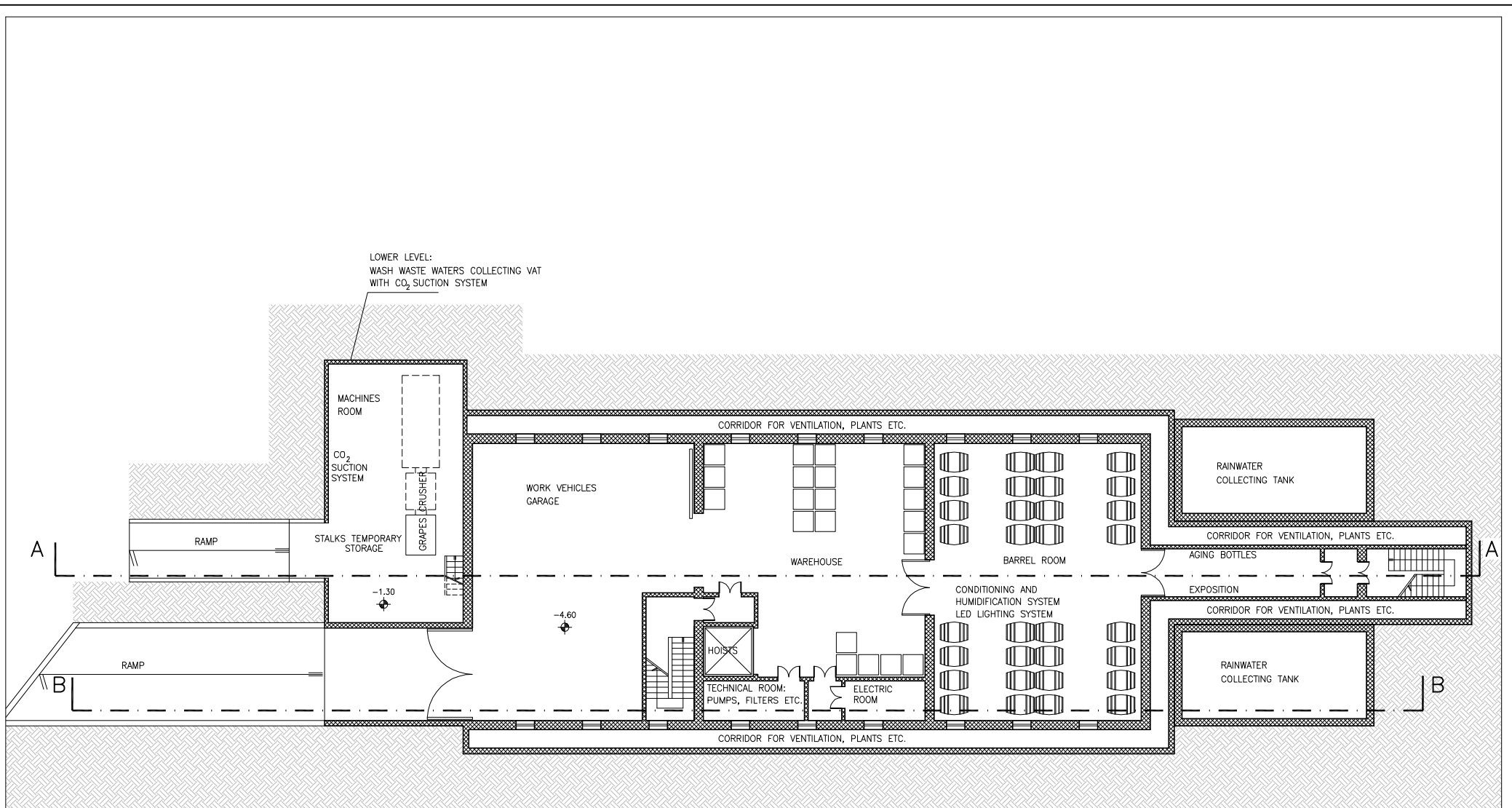

UNDERGROUND FLOOR PLAN
ELEVATION -4.60m

PROGETTO-DESIGN		
WINERY FOR GRAPES DRYING, WINE-MAKING, WINE AGING IN BARRELS, BOTTLING AND WINE SELLING		
DESCRIZIONE-DESCRIPTION		
UNDERGROUND FLOOR PLAN		
CODICE-CODE	T-3	SCALA-SCALE 1:200
REV.	0	DATA-DATE FEB-2011
<small>Questo disegno è di proprietà della ditta ALBRIGI sri, non può essere riprodotto o ceduto senza autorizzazione scritta. This drawing is property of ALBRIGI sri and may not be reproduced nor handed to third parties without a specific authorization from ALBRIGI sri</small>		

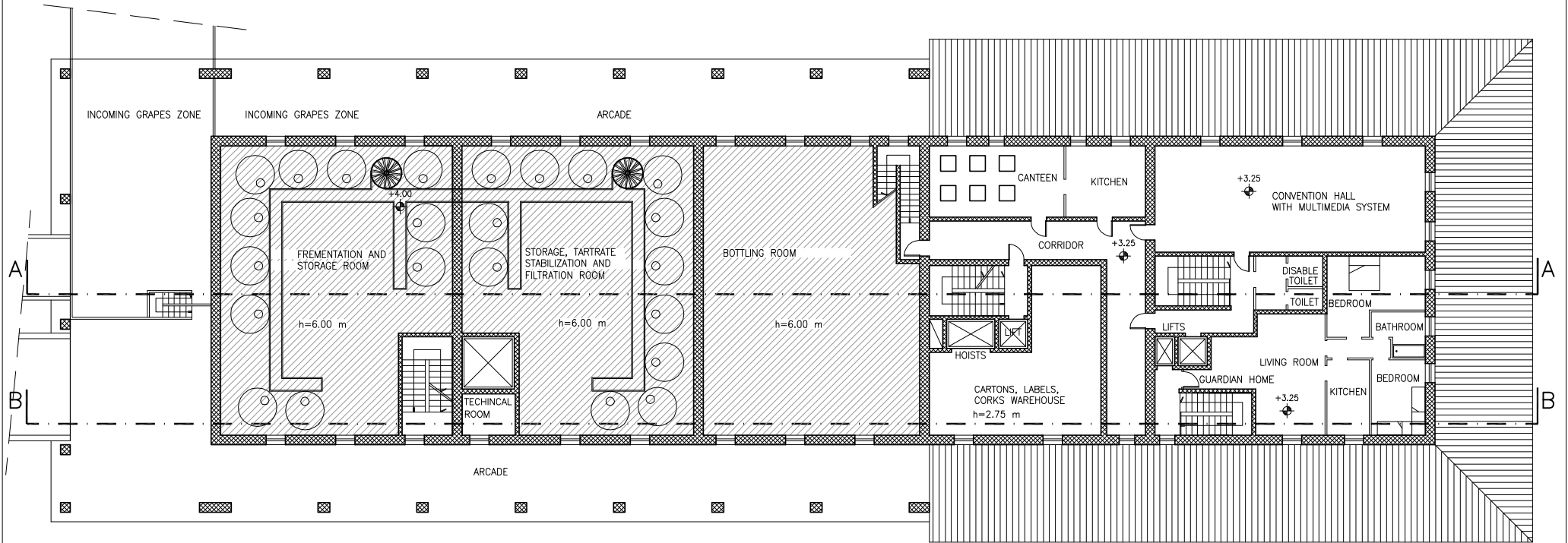

FIRST FLOOR PLAN : MEETING ROOM AND GUARDIAN HOME
ELEVATION +3.25m



PROGETTO-DESIGN				
WINERY FOR GRAPES DRYING, WINE-MAKING, WINE AGING IN BARRELS, BOTTLING AND WINE SELLING				
DESCRIZIONE-DESCRIPTION				
PIANTA PIANO PRIMO (ABITATIVO)				
ALBRIGI S.R.L.	CODICE-CODE	T-4	SCALA-SCALE	1:200
	REV.	0	DATA-DATE	FEB-2011

Questo disegno è di proprietà della ditta ALBRIGI srl non può essere riprodotto o ceduto senza autorizzazione scritta
This drawing is property of ALBRIGI srl and may not be reproduced nor handed to third parties without a specific authorization from ALBRIGI srl

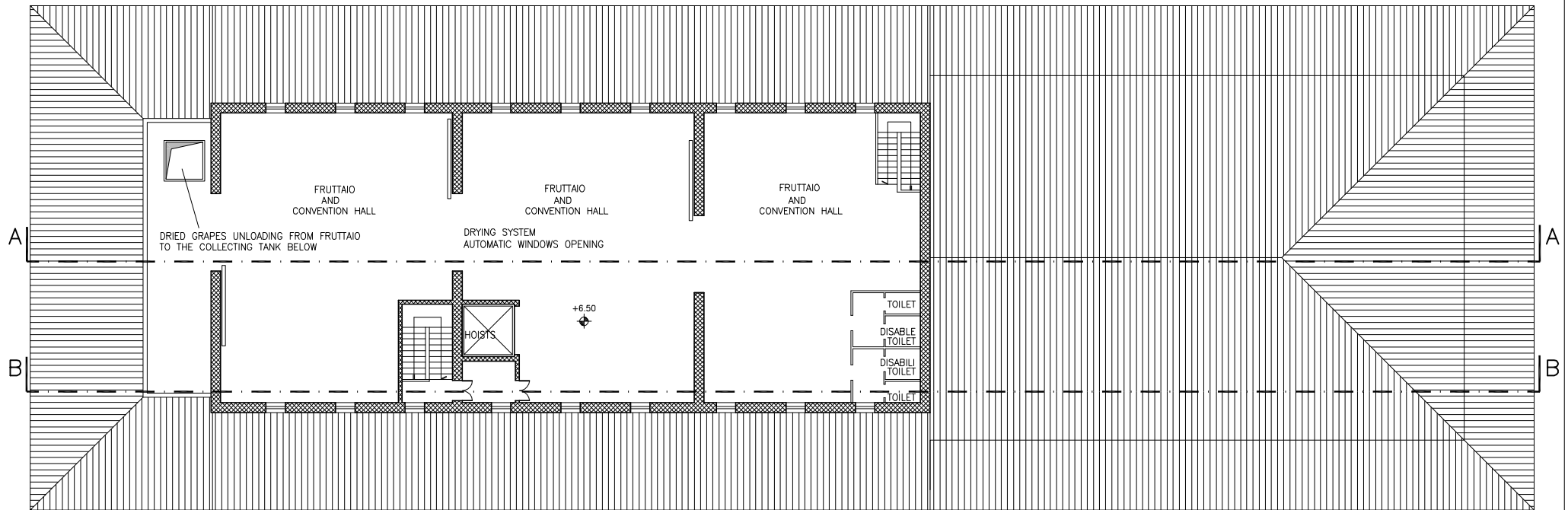

FIRST FLOOR PLAN : FRUTTAIO
ELEVATION +6.50m

PROGETTO-DESIGN		
WINERY FOR GRAPES DRYING, WINE-MAKING, WINE AGING IN BARRELS, BOTTLING AND WINE SELLING		
DESCRIZIONE-DESCRIPTION		
PIANTA PIANO PRIMO (PRODUTTIVO)		
ALBRIGI S.R.L.	CODICE-CODE	T-5
	REV.	0
SCALA-SCALE	1:200	
DATA-DATE	FEB-2011	

Questo disegno è di proprietà della ditta ALBRIGI srl non può essere riprodotto o ceduto senza autorizzazione scritta.
This drawing is property of ALBRIGI srl and may not be reproduced nor handed to third parties without a specific authorization from ALBRIGI srl

TECHNOLOGIES AND FACILITIES FOR THE NEW ECO-FRIENDLY WINE INDUSTRY

Albrigi Tecnologie, thanks to the experience acquired with its engineers and consultants, proposes the **best technical solutions for the new eco-friendly vine cultivation and wine industry**.

Albrigi proposes to its customers the state of the art winery, with the best structural and technological solutions, coming from the historical tradition of wine-making and looking at the future for a production of highest quality, efficiency and respect of the environment.

The idea consists in an **integrated system**, energetically efficient for the present and the next future. The preconditions are created since the **design** of the winery – i.e. the shape and the orientation of the building - which is going to work with precise seasonal strategies, taking advantage of natural energy sources and aiming in particular at the internal efficiency of the system.

The need to reduce as much as possible the production costs and the environmental impact leads to the use of **renewable energy sources** – like solar, geothermal, wind energy abundant in nature – and a set of solutions that involves every phase of the production. This starts from a **proper management of the vineyard and the winery**, with the construction of energy efficient buildings, the installation of specific energy-saving equipment (i.e. fermentation system, filtration without waste of flours or panels), the re-use of thermal energy and waste products. The **re-use** regards the heat exchangers, that can take advantage from thermal energy lost from the plants or the wine-making processes, the treatment of washing waste waters (re-used for irrigation), the biomasses obtained from agricultural activities (chipped branches and grapes stalks), products and additives of wine-making process.

This innovation is developed in accordance with in-depth studies on eco-friendly growth, made by public and private companies, universities and research institutes. Albrigi Technologies, working together with leading companies worldwide, propose to its customers the state of the art solutions in terms of product optimization.

The optimization of an efficient energy strategy is based on a strength integration of technological systems and the building that contains them. The **energy balance of sustainable system** depends on the right choice of specific design features and eco-friendly materials: it is advantageous, for example, to use natural lighting, to air-condition the rooms in summer or winter using geothermal system (possibly with drill arranged in the foundation piles), to collect rain waters, to provide buildings of efficient envelopes like double skin, radiant systems and using natural ventilation.

It is therefore essential to develop a **right work plan since the design stage**, both for the construction of a new winery or the renovation of an existing one or part of it, modernizing installations or tools.

For this purpose Albrigi Technologies created its own staff of experts in the different fields, which beyond consulting activities is able to study, design, construct and test installations and applications meeting the requirements of different customers. We have the know-how. The coordinator of our project is Mrs. **Francesca Poli** from Verona.

*

In the **following prospect** and notes you can find a summary of the **evolution of the new eco-friendly productive cycle** in the large survey of available technologies – referred to vineyards cultivation, installations, treatment and re-use of working wastes – finalized to productive and environmental quality.

ENERGY SAVING AND RE-USE OF PRODUCTS

‘FERTIRRIGATION’

This innovative way of fertilizing the vineyard consists in the distribution of fertilizers through irrigation water (with drip irrigation or sub irrigation); increasing the effectiveness of treatment, this method can save significant amounts of fertilizers, bringing economic and environmental benefits.

A further saving can be achieved by washing wine-making machines and pipelines with low or no amount of chemical products, in order to re-use washing waste water (within the parameters of the law).

VINEYARD DATA COLLECTION

In order to plan proper vineyard sanitary treatments, even considering the specific kind of treatment, it is essential to know in real time temperature and humidity in the vineyard. The control unit FAR SYSTEM detects and transmits the data continuously via GSM to the management system Archimede Albrigi, which archives data and sends the information to the operator.

INTEGRATED PEST MANAGEMENT AND ORGANIC FARMING

This is the new ecological philosophy aiming to reduce or eliminate as far as possible the use of pesticides harmful for the environment, promoting organic farming; the effectiveness of organic farming highly depends on the extension of territory involved in the practice and recently has been widely applied in many regions.

WIND ENERGY

The new mini or micro wind turbines, which are small and have low visual impact, produce electricity with higher efficiency than traditional wind turbines, because they can take advantage also from air turbulence.

ECO-FRIENDLY WORK VEHICLES

Work vehicles with Euro 5 or electrical engines reduce pollution in the vineyard and are widely used abroad.

ALBRIGI ARCHIMEDE

Albrigi’s “Archimede” system, expandable and customizable, allows to manage and control every wine-making process and every machine, even through remote control: activities in the country (vineyard map, phytosanitaries treatments management etc.), wine-making plants in the winery (tank conditioning, fermentators programming, washing management etc.), wine-making and storage rooms (temperature and humidity control in the barrel room, ventilation in “fruttaio” etc.), energy saving systems (geothermal drills and heating pumps, lighting, solar panels and photovoltaic panels etc.), so that the systems features and product quality can be optimized.

SUNLIGHT CONCENTRATOR MIRRORS

This technology (that can achieve several hundreds degrees temperatures by concentrating sunlight on a tube placed on the focal line of the curved mirrors) is really suitable to the winery because it provides hot water and steam with small plants, much smaller than traditional solar panels, and consequently with low visual impact.

3RD GENERATION PHOTOVOLTAIC PANELS.

According to the news, new cheap photovoltaic panels are being developed, with significantly higher efficiency compared to the traditional ones (up to 40%); at a parity of energy production, the necessary surface of panels is much lower than traditional panels, with obvious economic, managing and visual impact advantages.

SOLAR PANEL FOR WARM WATER

Besides the well known warm water production, solar panel, combined with new technologies, can be used to produce cold water. Kloben company produces special heat exchangers that can transform thermal energy in refrigerating energy, what is necessary in the cellar for fermentation tanks conditioning, storage rooms, office or residential areas conditioning.

HEATING PUMP

This is a largely developed technology, that uses heat and cold energy from the ground or from deep underground waters, through geothermal drills and heat exchangers working with air or water. Power supply for the heating pump can provided by solar panels, reducing pollution. As this are very silent machines, noise is definitively reduced.

BIOMASS BURNERS

Biomass burner is at this time evidently useful to produce hot water (for washing, rooms heating, fermentation tanks conditioning) and steam, what is necessary to sterilize filtration equipments, tanks, pumps and bottling machines.

ECO-FRIENDLY ARCHITECTURE

The target is ecosystem preservation, eliminating or reducing as much as possible, the impact of productive activities on the environment. Design takes up to energy self-sufficient buildings - with low polluting emissions - which are able to exploit natural sources and renewable energies.

FRUTTAIO

In the fruttaio, where are concentrated large quantities of grapes for drying, is often necessary to integrate natural ventilation with mechanical ventilation and drying systems, managed by an automatic control unit which detects and selects the right parameters for proper dry of grapes and automatically opens or closes windows.

BARREL ROOM

Traditional barrel rooms, with clay floor and breathable walls, are built to maintain naturally the ideal humidity and temperature for barrels rest. Due to the modern sanitary standards imposed by law – which require cleanable, non breathable, floor and walls coatings – barrel rooms need now special equipments for air conditions detection, which are able to manage specific air-conditioning systems and keep the right humidity and temperature for barrels rest.

ALBRIGI’S HIGHT CLEAN TANKS

Albrigi Tecnologie’s tanks, thanks to a particular treatment of stainless steel that makes the inner surface completely free of bumps, can be cleaned with hot water or steam only, without chemical products; in this way you can reduce environmental pollution and re-use waste wash waters and regenerate cleaned tartaric acid for the next fermentation process.

GRAPES WASHING BEFORE CRUSHING

Grapes washing and drying before crushing eliminates residual impurities from the must.

INTEGRATED SYSTEMS FOR AIR CONDITIONING WITH FILTERED AIR

Room where alimentary products are treated need a heating-refreshing system with filtered sterile air. Using renewable energies you can use floors, walls and ceilings as heating exchangers for the heating system.

“ZERO KILOMETERS”

Reducing transportations and choosing, as far as possible, supplies and activities located near your company combines clear management advantages and a strong reduction of polluting emissions in the environment.

LIGHTING AND ENERGY SAVING

Led lighting technology perfectly fits with cellar needs, because led lamps have very much higher efficiency and life than the traditional ones, in addition to the possibility of varying light intensity and color. Led lamps are cool, and so ideal for rooms where you shouldn’t introduce heating sources, like the barrel room.

WASTE COLLECTION

By separately collecting the different kinds of wastes or wine-making products, you can regenerate and re-use products that you are allowed to re-use, sparing money for companies specialized in wastes disposal.

REGENERATION OF BRANCHES AND GRAPE-STALKS

Branches and grape-stalks can be reused for heating production, upon chipping or pelletizing and storage in bins for automatic feeding of biomass burners.

REGENERATION OF WINE-MAKING PROCESS PRODUCTS

Washing the tanks with hot water, without chemical products, it is possible to regenerate cleaned products of wine-making process (grape-stalks, tartaric acid, grape-stones), which can be reused in the next fermentation process or in wine treatments. This is being studied at the University of Verona, by prof. Ferrarini.

COLLECTION AND FILTRATION OF CO2 AND NATURAL FERMENTATION AROMAS

Volatile substances produced during fermentation process can be collected and treated, reducing polluting emissions of CO2 (fixing it on special supports as a carbonate) and regenerating alcohol and natural aromas of the fermentation process, that can be re-used.

WASTE WATERS PHYTOPURIFICATION AND MEMBRANE BIOREACTORS PURIFICATION

Phytopurification and membrane bioreactors purification allows you to re-use waste waters, within parameters of law, for irrigation, ‘fertirrigation’, or to distribute sanitary treatments to the vines.



A third of a century of evolution

SYSTEMS TO BE INSTALLED FOR THE TEACHING AND PRODUCTION



PRODUCTION

QUALITY

Detection station for temperature and humidity in the vineyard, and data transmission to the computerized management system, powered by a dedicated photovoltaic panel

Integrated pest management and organic farming

New micro wind turbines

Tractors and vans EURO 5 or electrical

Fertilization and irrigation: drip irrigation or subirrigation, even through reuse of treated waste waters of the winery

ENERGY

QUALITY

ALBRIGI "ARCHIMEDE"

Stunlight concentrator mirrors for steam production

3rd generation photovoltaic panels; high efficiency (up to 40%)

Solar panels for water heating, special exchanger for cooling and tank conditioning

Geothermal drills with heating pump:
- ground-water system with horizontal drills
- ground-water system with vertical drills
- water-water system with well

Biomass burner (branches, grape-stalks) for steam production, to wash filters, pipes, pumps, boiling machine

Total control and management of your winery and energy saving systems

Integrated condensing boiler

RECOVERY

ENVIRONMENT

Phytodepuration and reuse of winery waste waters

Depuration with diaphragm bioreactor and reuse of winery waste waters

Collection and filtration of CO₂ and natural aromas of fermentation process

Regeneration and reuse of grape-stalks, yeasts, tartaric acid and grape-stones

Regeneration of branches (chopped) and grape-stalks for heating production from biomass

Waste collection

CELLAR

ENVIRONMENT

ALBRIGI HIGHT CLEAN Tanks: washing with hot water or steam only, without chemical products

ECO-FRIENDLY ARCHITECTURE: Eco-friendly buildings, Natural materials and supplies

FRUTTAIO: Automatic humidity and ventilation control, Automatic system to open/close windows, automatic fans start

BARREL ROOM: Automatic humidity and temperature control

Wash/dry machine for grapes (before pressing)

Filtered air or floor heating system

LIGHTING:
- lamps powered by photovoltaic dedicated panel
- cold led lamps

km 0 activities

ALBRIGI
TECNOLOGIE
A third of a century of evolution

PRESENT: FEATURES FOR THE NEW WINE INDUSTRY AND ENVIRONMENTAL SUSTAINABILITY



ALBRIGI
TECNOLOGIE
A third of a century of evolution

SYSTEM FOR TOTAL MONITORING AND CONTROL OF CELLAR WINEMAKING EQUIPMENT

The Archimede system consists of a leading-edge electronic console that connects to each appliance that produces power and services in order to manage it and monitor it, such as a fermentation tank to be programmed. This elegant steel control board independently carries out a myriad of procedures, setting up even complex work cycles or independent work recipes for each appliance or stainless steel container. It can automatically manage and monitor a great number of procedures such as loading and weighing the grapes, heating and cooling the various fermentation or process phases, schedule automatic washing cycles, carry out plant reset functions and many other services as described below. The system can also be remote-controlled by sending SMS.

This is an open system that can be expanded to include new functions without having to replace the existing one. Each unit has a graphic display and a multifunction keyboard with push-buttons dedicated to each desired function.

Automation is basic because it achieves the highest processing quality levels by real-time measurements of process parameters, optimizing winemaking systems in function of the product being processed.

Sophisticated customized and exclusive supervision software makes it possible to customize and program all the many checks that need to be performed on existing equipment. You can also intervene immediately on each container or process equipment, directly from the console. The system can generate and recreate historical data, filing them for 10 years in a tabular and graphic format so that they can be compared with theoretical values and then interfacing these values with the system management.

And there's more: the system also monitors ambient parameters in the processing and storage areas so as to always keep temperature and humidity values at desired levels. And you can dialogue with the system from any point in the world, using a mobile phone or even using Skype, connecting directly to the system and making precise checks and variations in real time at the minimal cost of one SMS or one telephone call of just a few minutes.

The system can also implement "traceability". In this way the world becomes even smaller and, thanks to Archimede, everything is under control.

LIST OF SERVICES MONITORED IN THE COUNTRYSIDE

- Company map
- Vineyard map (grape selection)
- Genetics and wine archive
- Irrigation
- Management and programming of vineyard treatments
- Remote monitoring of outdoor atmospheric conditions in vineyards by radio
- Video monitoring of vineyards by radio and filing of data
- Pre-harvest
- Harvest
- Weighing
- Grape selection
- Management of motor vehicles in the vineyard
- Management of wells or irrigation systems with monitoring of water supplies

LIST OF THE MUST FERMENTATION AND PROCESSING PROCESSES IT MONITORS AND MANAGES



ARCHIMEDE
minor wine

ARCHIMEDE
major wine



A third of a century of evolution

info@albrigi.it • www.albrigi.it

- Grape refrigeration
- Heat-treatment of musts and pressed grapes
- Cryomaceration (Criotank)
- Bâtonnage (Bâtontank)
- Processing of fine lees
- Pumping over
- Punching down (Monofolltank)
- Rotating blade (Volvotank)
- Submerged cap (Supertank)
- Cascade (Pluviatank)
- Pump over turbine (Turbotank)
- Mechanical délestage (Délestage)
- Carbonic maceration (Noveltank)
- Ice wine
- Cold clarification (Chiaritank)
- Cold malolactic
- Délestage (Délestage)

MONITORING AND MANAGEMENT OF PROCESSES AND SERVICES

- Management of supplier grapes
- Accounting management of grapes for passerillage raising
- Grape passerillage raising and climate control in the fruit warehouse
- Crushing - Pressing
- Monitoring, management and filing of fermentation data during the different phases
- General wine cellar management and control of the quantities of musts or wines in tanks or fermentation tanks
- Management of systems and equipment for pressing, filtering, pumps, racking, topping off
- Grape and wine refrigeration
- General wine cellar climate control
- Temperature and humidity management in the aging barrel cellar
- General heating
- CO2 suction from the wine cellar
- Air/nitrogen production
- Steam production
- Management of washing plant
- Management of bottling plant
- Label - carton - cork - bottle - cap - glue warehouse
- Monitoring of drain waters
- Management of lighting and ventilation in the wine cellar
- Operating costs
- Accounting and warehouse management - Suppliers
- Invoicing - Customer management - Transport management
- Marketing management - Agent management
- Event management
- General management of energy production systems in the wine cellar
- Monitoring of alternative energy sources
- Energy savings - Heat pumps, geothermal energy, photovoltaic panels, mirror screens - Data transmission - Burglar alarm - In-house security monitoring - Kidnapping alarm
- Satellite monitoring of services and measurements
- Plant alarm warned by mobile phone

EVERYTHING IS UNDER CONTROL



ALBRIGI
TECNOLOGIE
A third of a century of evolution



Albrigi means fantasy

Picturetank
in your winery
with subject
of your choice



ALBRIGI
TECNOLOGIE
A third of a century of evolution

Albrigi srl
Via Tessare, 6/A • 37023 • Stallavena - Grezzana (VR) - Italy
Tel.: + 39 045 907411 • Fax: + 39 045 907427
e-mail: info@albrigi.it • <http://www.albrigi.it>

Albrigi means highest quality

ALBRIGI
TECNOLOGIE
A third of a century of evolution



ALBRIGI
TECNOLOGIE

Via Tessare, 6/A • 37023 - loc. Stallavena di Grezzana (Verona) • Italy
Tel.: + 39 045 907411 • Fax: + 39 045 907427
e-mail: info@albrigi.it • <http://www.albrigi.it>

